

SECRETS OF

BILLION
1724

THE 200 MPG CARBURETOR

A TECHNICAL EXPOSE OF THE WORLD'S AUTO MAKERS

By **ALLAN WALLACE**

PREMIER PUBLISHERS—Fort Worth, Texas USA

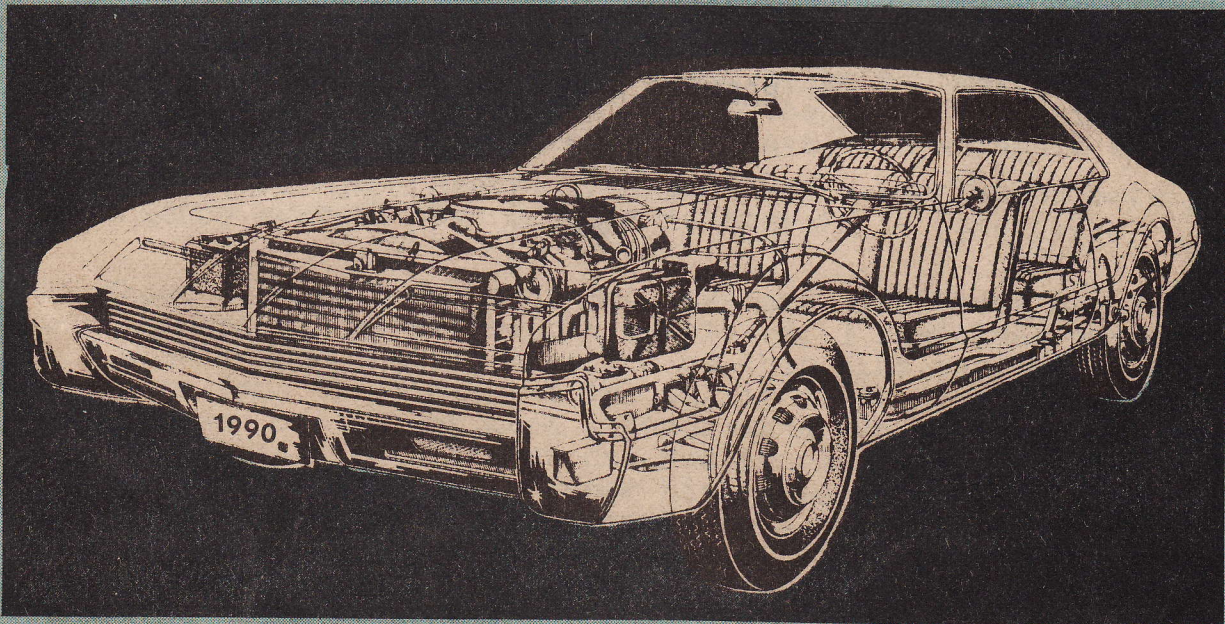

Copyright © 1980 By Allan Wallace

Sixth Printing March, 1982

I hereby dedicate this book
to those of you who are the
dreamers of this country -

You are the people who make
the greatest technical ad-
vances possible when you do
something about your dreams

Allan Wallace

Published by

PREMIER PUBLISHERS

Fort Worth, Texas



1979 - Ralph Moody Jr of Oak Hill Florida gets 84 miles per gallon from his modified Ford Capri which has been equipped with a turbocharged 4-cyl Perkins diesel engine.....

1978 - The Flex Gas Vaporizer (as advertised in national magazines) and sells for a reasonable price, claims to double gas mileage from most any car and gets to 110 MPG on some.....

1977 - A standard VW Rabbit diesel with turbocharger is tested and gets up to 55 miles per gallon.....

1977 - Tom Ogle of El Paso Texas claims to get 100 miles per gallon on his 4600 lb 1970 Ford Galaxie with V-8 engine. Running one round trip test from El Paso Texas to Demming New Mexico and back used only two gallons of gas. His Vapor Fuel System eliminates the standard carburetor, only has a three gallon tank and emits no carbon dioxide or unburned hydrocarbons....

1976 - A modified Ford Pinto equipped with a turbocharged Nissan diesel engine is tested and gets to 80 miles per gallon.....

1974 - An article from Mechanix Illustrated about "Humidifier Type Fuel Systems" tells of a man by the name of LaPan who claims to get from 60 to 100 miles per gallon with his system.....

1973 - The annual Shell Oil Company employees contest turns out a world record for high mileage at Wood River Illinois. A highly modified Opel of 1959 vintage sets the record with 376.59 miles per gallon.....

1968 - Ford Motor Company begins experiments with an engine that has a different kind of combustion chamber. A fuel injected version of 430 cid is tested and runs very well on an Air/Fuel mixture of 26:1 - Ford is now experimenting with this engine for possible production by 1985.....

The late 50's and early 60's - The Kendig and Fish variable venturi carburetors have some very interesting mileage figures, the Fish even gets into production on a very small scale - but for reasons unknown, both of these carburetors fade away over the next few years.....

1933 thru 1936 - Charles Nelson Pogue is issued several patents on his vaporizer type carburetors and claims of 200 miles per gallon crop up all over the world. He never gets production off the ground and his carburetor fades away, but Mr Pogue and his carburetor have been a legend ever since.

More than 50 years ago - George Arlington Moore was issued more patents on fuel efficiency systems than any man in history to date.....

Are all these stories true? You bet they are, and these are just a few of the many thousands that we haven't mentioned. I sometimes wonder about our society when I find that information of this kind can be dug up by anyone who wants to take the time, but the public never seems to get informed on any kind of mass scale. But then I guess when you think about it, when every one is informed they all want one and stories like these can panic the oil industry. If one of these super high mileage systems were to ever make it to market on a mass scale it could ruin our economy by literally putting millions of people out of work. One of six people who work in this country depend directly on the automotive industry for their paychecks, & who knows how many depend on the oil industry. If the oil companies could only sell half as much gasoline next month as they sold last month they would certainly have to fire one hell of a lot of people to keep from paying out that huge payroll for which they would not have the money. You see our whole economic system is built on automobiles and gasoline...

Because our economy is based on the automobile and the gasoline it uses all these inventors who come up with a better idea, are never allowed to get their invention onto the market. Of course you will never get any one to admit that inventions can be suppressed, but never the less - they do.

I have put this information together from the research I have done in my own venture to build a super high mileage system. Because it would take a set of volumes the size of an encyclopedia to give you all my research notes, I've included only the most interesting and **feasible** systems into this book. I feel the public has a right to know and be given the knowledge to produce their own system if they so desire and to run it on their own automobiles. If enough people are running around in 100 MPG cars, the economy will have to change and industry will have no choice but to go along with the change...

It seems that ever since the advent of the automobile, the public has been buffaloed into **believing** that the carburetor installed on our cars is the most efficient that can be produced. And that an Air/Fuel ratio of 15:1 is the ultimate mixture for gasoline to burn. But this is not true - gasoline will burn at mixtures of up to 200:1 and the 15:1 ratio - is the biggest outright lie we've ever heard. The carburetor, as installed on the automobile for more than 50 years now, is nothing more than an automatic fuel flow control valve - it does not vaporize the fuel at all, which must be done before the fuel will burn. 15:1 is about the correct mixture when you intend to burn only 10% of the fuel as is done by some automobiles. Liquid fuel will not burn, it must be in a gaseous state (vaporized) **before** it will burn - and the carburetor does not do this.

The carburetion system begins at the point of air entry into the system and ends at the point of ignition, **therefore** - the intake manifold and the heads are part of the carburetion system as are the combustion chambers. **The** heat within these parts of the system **is** what tends to vaporize fuel so that it can burn. The carburetor only turns the fuel into a fine misty spray and meters it to coincide with the air flow. In the average car of today - only about 20% of the fuel ever gets vaporized for the burning process, the balance is what ends up as carbon **build-up** inside the engine and what is called unburned hydrocarbons being collected by the catalytic converter or coming out the tailpipe.

You can disprove the 15:1 Air/Fuel ratio with your own car and a little of your time. Fill your tank and then take your car out on the highway, drive at 55 miles per hour for one hour - turn around and return to the same station you filled up at and refill your tank. Note the mileage on your odometer at the beginning of the test and at the end. Now go home and get out your calculator. You're going to figure the Air/Fuel ratio for the engine under ideal conditions at a steady speed. You drove 110 miles now figure your mileage by dividing the number of gallons to refill your tank into the 110 miles. Now say for example if you got 18 miles per gallon, you used 6.1 gallons of gas - at six lbs per gallon that is 36.6 lbs. Now you will have to figure the amount of air you used, and at 13.1 lbs per cubic foot. If your engine is a 300 cubic inch V-8 and turns 2250 rpm at 55 miles per hour (find this out by installing a tachometer) it will draw in 11,718.75 cubic feet of air per hour -two hours will be 23,437.5 cubic feet or 1,789.1 lbs. Now divide the air by the fuel (1,789.1 lbs air and 36.6 lbs fuel) and you get a Fuel/Air ratio of almost 49:1.....

THE formula for fuel ratio to air is always figured in **weight**, so the

correct formula is as follows: Gasoline at 6 lbs per gallon / air at 13.1 lbs per cubic foot. --- Cubic inch displacement of engine divided by two (piston draws air only on every other stroke) multiplied by engine rpm divided by 1728 (1728 cubic inches per cubic foot) multiplied by 60 (the number of minutes per hour) equals cubic feet of air / gasoline gallons multiplied by 6 lbs equals weight of gasoline / cubic feet of air multiplied by 13.1 equals weight of air -- divide weight of air by weight of gasoline consumed for same period of time equals Air/Fuel ratio.

It's plain to see that if you get a 49:1 Air Fuel ratio at a steady speed on the highway and if your carburetion system is only 20% efficient, a 60 to 80% efficiency would increase mileage drastically. If you are getting 18 mpg now and could increase efficiency to 80% your mileage would be better than 70 miles per gallon...

The carburetor as we know it is about the same as it was 50 years ago and the modern carburetor is even less efficient than those of 30 years ago when gasoline was cheap. The fuel injection systems of today are not much better than a standard carburetor when it comes to efficiency. To sum it all up, of every 20 gallons of gasoline you put in your tank - only 5 gallons or so will be used by your engine. The balance will build up in the engine as carbon and will be collected as unburned hydrocarbons by the catalytic converter or come out your tail pipe as pollution...

I once drove a 1956 pontiac with V-8 and automatic transmission that got about 13 mpg on the highway. I was a hot rodder in those days and I wanted as much power as I could possibly get so I set out to get the car to go a little faster. I had just come out of the Air Force where I was an engine mechanic so I used one trick that airplanes use to get more power for take offs. I leaned the carburetor out as much as possible and put in water injection to help keep it cool. The leaning process did give me more power, but due to the liquid fuel within the combustion chamber the heat build up was intolerable until the water injection was installed. At the same time I was increasing power with this method - I found out that I was also increasing efficiency and ended up getting better than 21 mpg on the highway...

Ever since then I have been interested in high mileage systems and am at present working on a simple modification that could better than double the mileage on any car that uses gasoline and a standard carburetor. As a result of my research I have put together the following information for you to use as you see fit in your own endeavor to obtain better mileage in your automobile. However the printed material here has been copyrighted and may not be reproduced for resale. Dealerships for this book are available though; contact the dealer where you bought this book for more info or contact me directly if he cannot help you.

I truly hope the information given here will be of some help to you & I hope to see many automobiles running around getting 50 mpg or better in the next few years. Maybe we can get our economy to start changing for the better if we do something about it.....

December 28, 1971

Inventor: JOSEPH H BALDWIN

Patent #

3,630,698

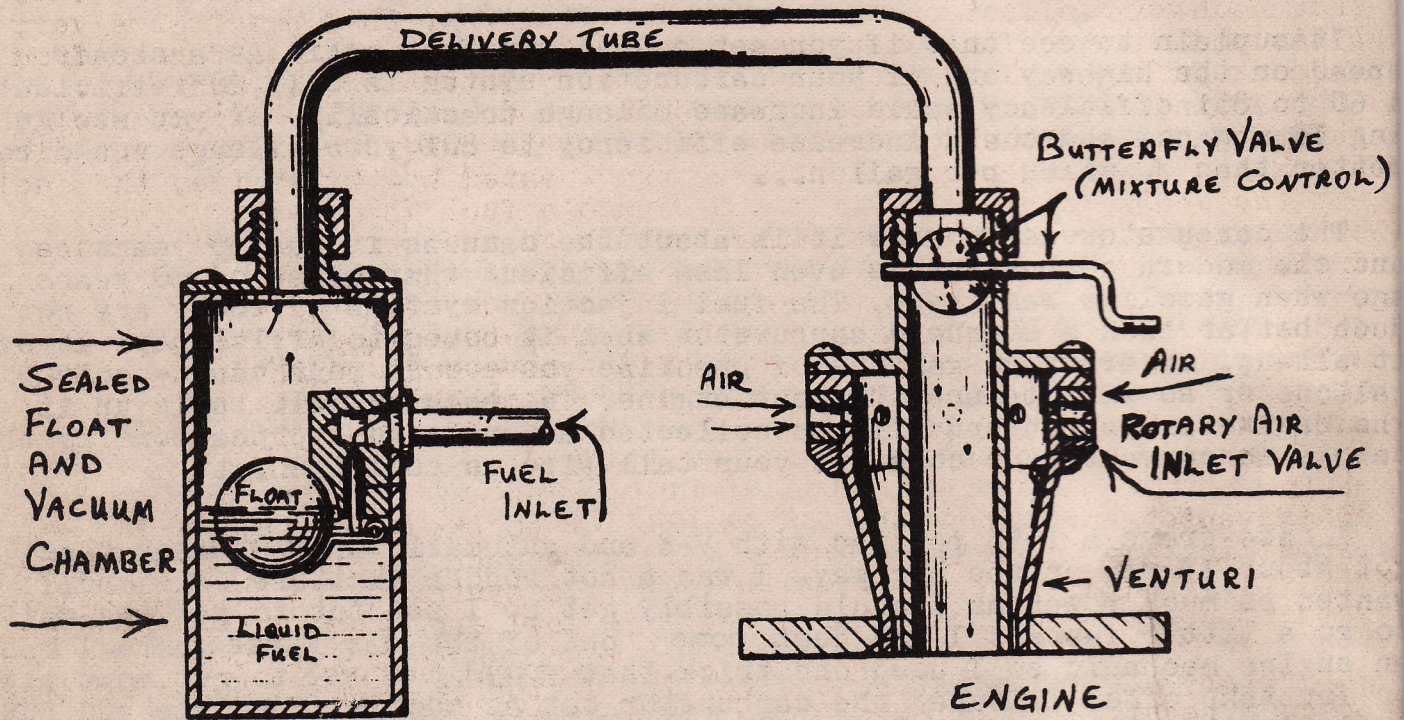

FIG. 1
SIDE VIEW

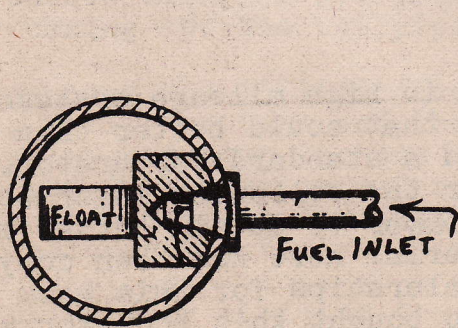

FIG. 2
TOP VIEW
(FLOAT/VACUUM CHAMBER)

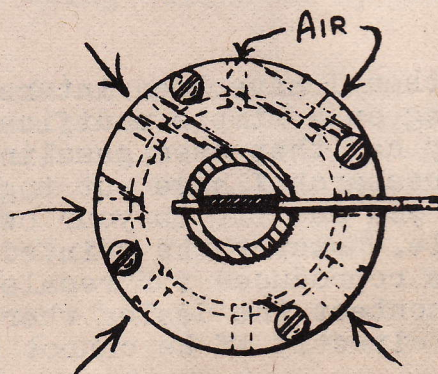

FIG. 3
TOP VIEW
(VENTURI)

The Baldwin carburetor shown here is of a type that uses a vacuum which is created by the engine to lower the pressure on the surface of the fuel and thus boiling the fuel to produce a vapor. It eliminates the standard venturi type carburetor with jets entirely, and replaces it with a sealed chamber containing a float with a standard needle & seat - a delivery tube and a venturi type air inlet and mixture control.

In the Baldwin system, air is cut off by the rotary air inlet valve to produce a choking effect on the engine for starting. This produces a very high vacuum and therefor boils enough fuel to get the engine started from the vapors produced along with the air already in the intake manifold. After starting, the air valve is opened enough to continue operation of the engine and from then on acts as the throttle valve to control the air entering the engine. Because of the vacuum created by the engine, the fuel within the sealed chamber boils and produces a fuel vapor - this fuel vapor is then sucked along the delivery tube to the venturi type mixture control.

Within the venturi type mixture control is a butterfly valve to control the flow of these vapors and this butterfly valve must be connected with linkage to the rotary air inlet valve so as to be able to control the Air Fuel mixture. The rotary air inlet valve can be of any type that will do the job and can be connected to the accelerator pedal for throttle control.

The inventor says that heat may be applied to the sealed chamber for better efficiency (in effect, not requiring so much vacuum to boil the gas within it). No fuel pump is required with this system as the vacuum within the sealed chamber will continue to suck in fuel from the tank as required.

The rotary air valve is the controlling factor in this system producing the vacuum required by allowing less air into the engine. It may be very difficult to get this system to allow an engine to turn a high rpm and may produce a loss of power for the lack of air. However the system will work and could be experimented with to get the size of the valve and venturi to the point required for high rpm. The inventor makes no specific claims as to mileage, efficiency or pollution produced by his carburetor.

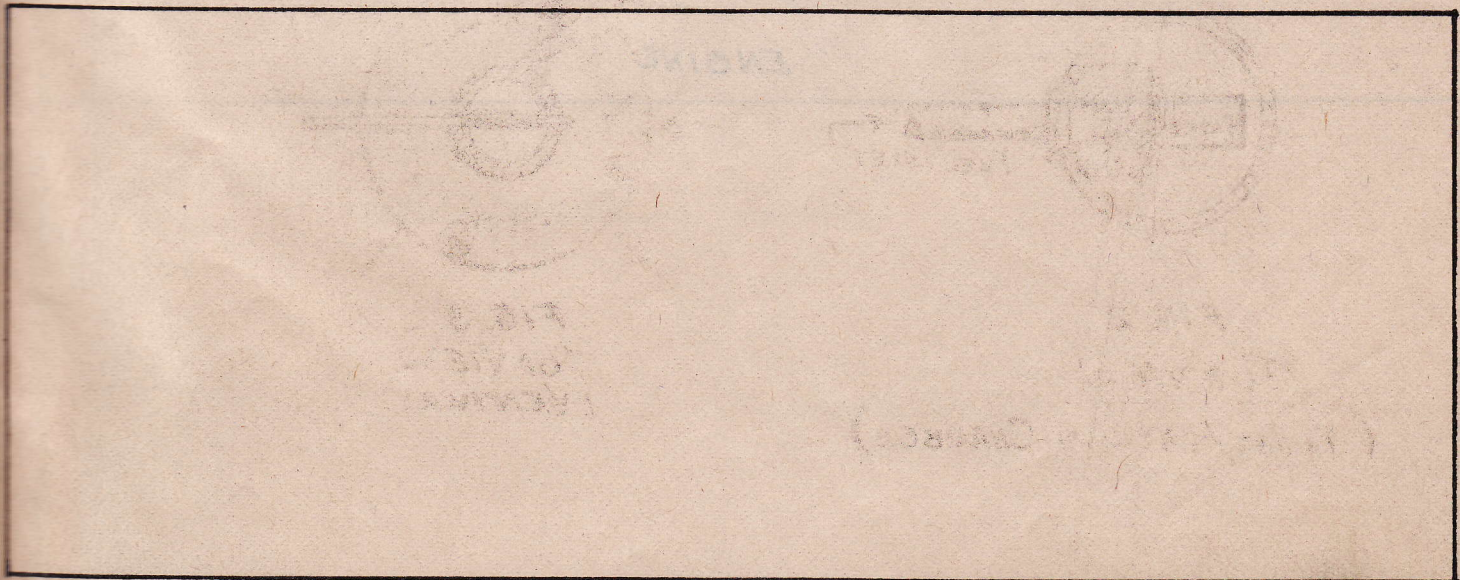

April 4, 1972

Inventor: OLIVER M TUCKER

Patent #
3,653,643

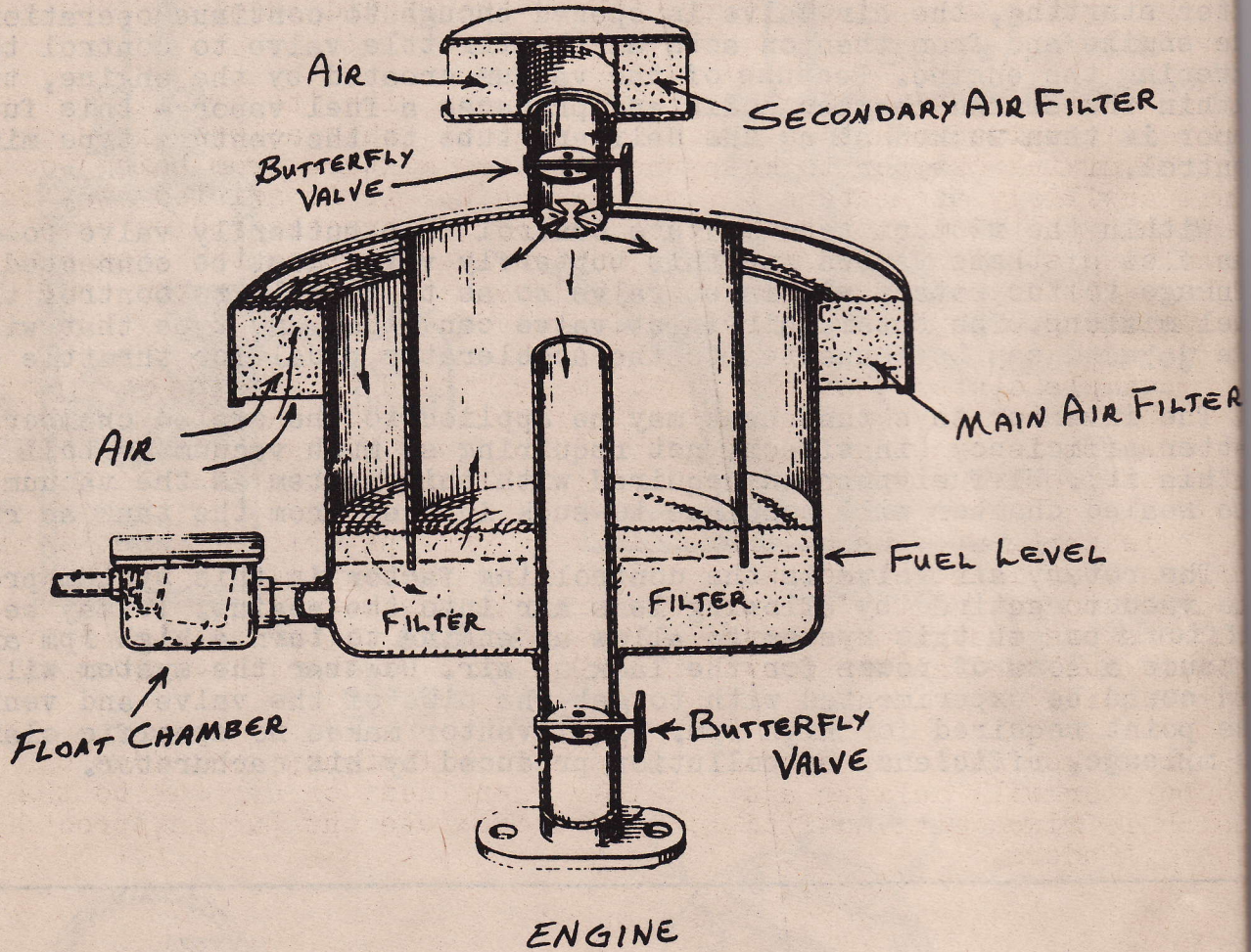

The Tucker carburetor shown here is basically a system of fuel and air filters working together to create a vaporous mixture sufficient to burn within the cylinders of an internal combustion engine.

Because the bottom of this carburetor is filled entirely with the main vaporizing filter, a float chamber must be mounted separately and at such a position as to maintain a fuel level below the top of the filter. Main air entry into the carburetor is through an ordinary type air filter, and the air then passes downward into and thru the main vaporizing filter and the liquid fuel where upon it bubbles upward into a mixing chamber. The air passing thru this liquid fuel and filter creates bubbles which are broken up by the part of the filter above the liquid level thereby vaporizing the fuel.

An auxiliary air inlet is provided along with its own air filter and a butterfly valve to act as a mixture control, this allows extra air to enter the mixing chamber to keep the original mixture from being too rich. As this auxiliary air enters the mixing chamber it is swirled away from the center by a turbulator to help in the mixing process and to keep it from traveling straight down into the engine and creating too lean a mixture. This auxiliary air must be controlled by linkage to the the accelerator pedal along with the main butterfly valve control .

A simple system that works well when fitted to stationary engines where the engine rpm is constant. Mixture control by linkage can be tricky when engine rpm is constantly changed up and down. Mixture control can be your biggest problem when building any high mileage carburetor.

This carburetor is of the basic form or type written about in an article from a 1974 issue of Mechanix Illustrated where a man by the name of LaPan claimed to get 60 to 100 mpg. The article was more about humidifier type carburetors though, where the main vaporizing filter rotates through the liquid fuel and air is drawn through a part of the filter that is not under the liquid.

Mr Tucker makes no specific claims to efficiency, but does claim this carburetor will deliver a completely vaporized or dry gas to the engine which is mixed with sufficient air to complete the burning process within the cylinders.

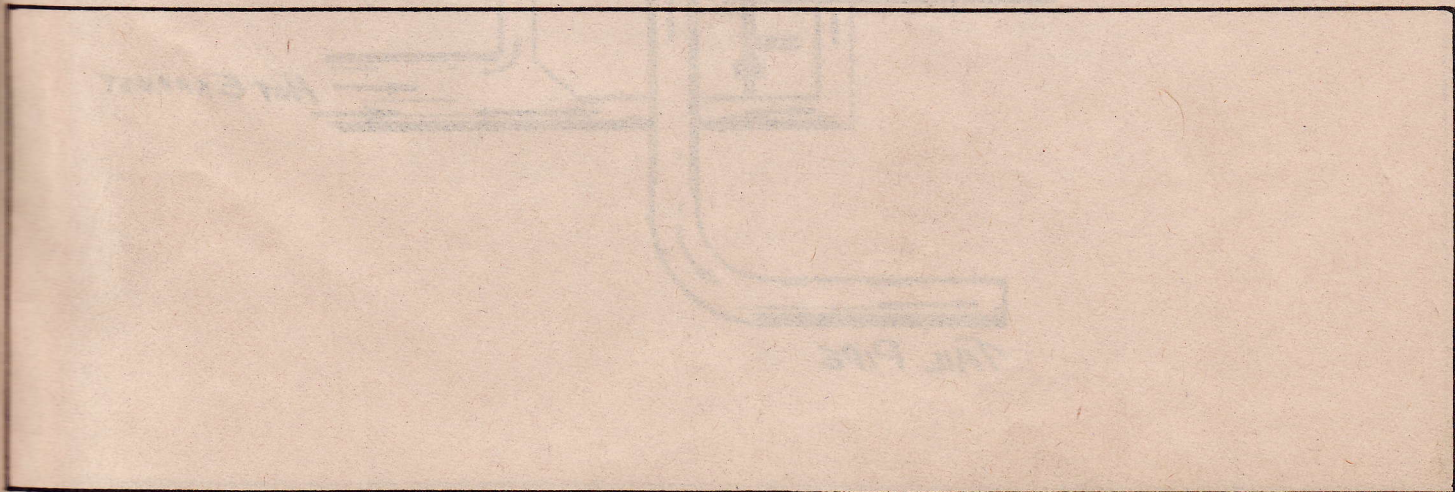

February 24, 1970

Inventor: FORREST E GERRARD

Patent #
3,496,919

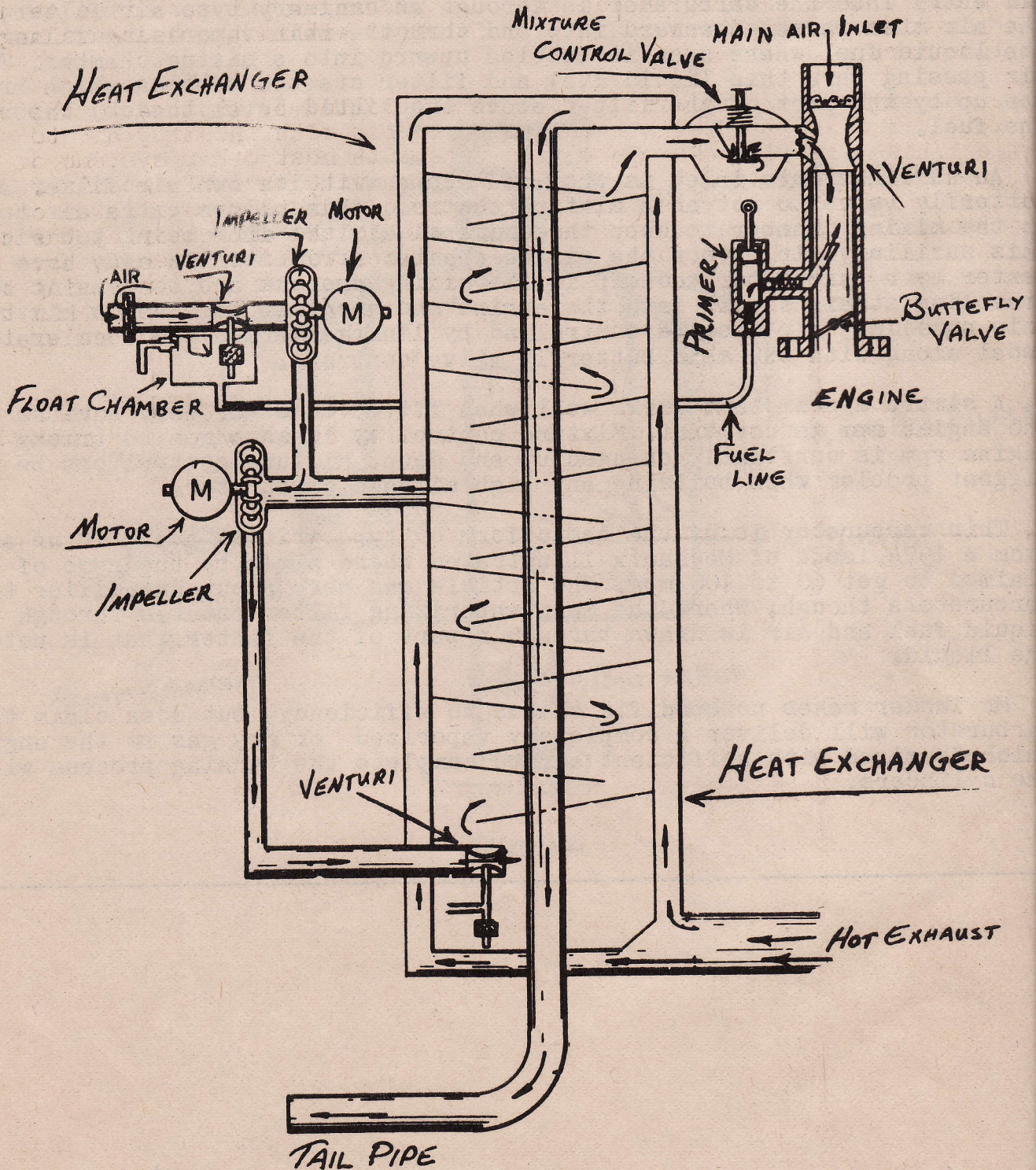

The basics of the Gerrard carburetor shown here are simple, but can be a bit complicated to build. It works on the basis of a simple heat exchanger to vaporize the fuel.

This carburetor uses two impellers driven by electric motors to suck air through a venturi type fuel nozzle, and then send this atomized fuel & air mixture through a heat exchanger to fully vaporize the fuel. This vaporized mixture then remains inside the heat exchanger til such time as needed by the engine. A slight pressure is maintained within the heat exchanger by the impellers.

As the engine requires fuel, a valve controlled by linkage to the butterfly valve is opened and allows the vapor to mix with incoming air to the engine. This valve for mixture control, as with most other systems of this type, can be tricky to get into co-ordination with throttle opening. This carburetor is a simple version of the Pogue carburetor shown later on in this book, and could be highly dangerous due to the air entering the heat exchanger along with the fuel. The wise builder would be wise to have one or more heat control valves affixed to keep temperatures from rising to a point where the fuel will explode. Also this air/fuel mixture within the heat exchanger should be kept very rich, so rich in fact, that an explosion would normally be impossible.

No specific claims are made by the inventor other than complete burning of the fuel and a reduction of pollutants being released to the atmosphere.

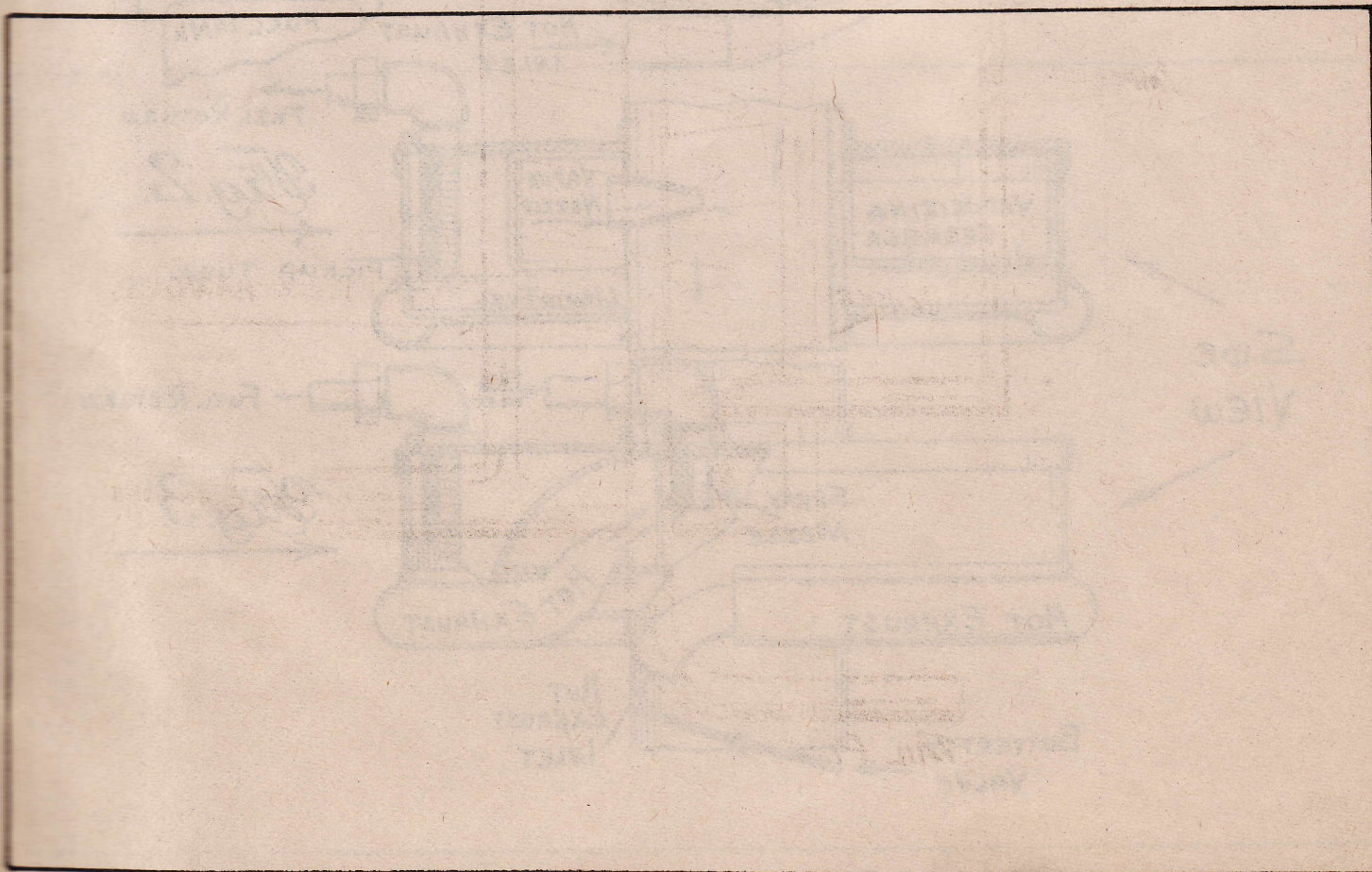

December 26, 1966
Inventor: HAROLD SCHWARTZ

Patent #
3,294,381

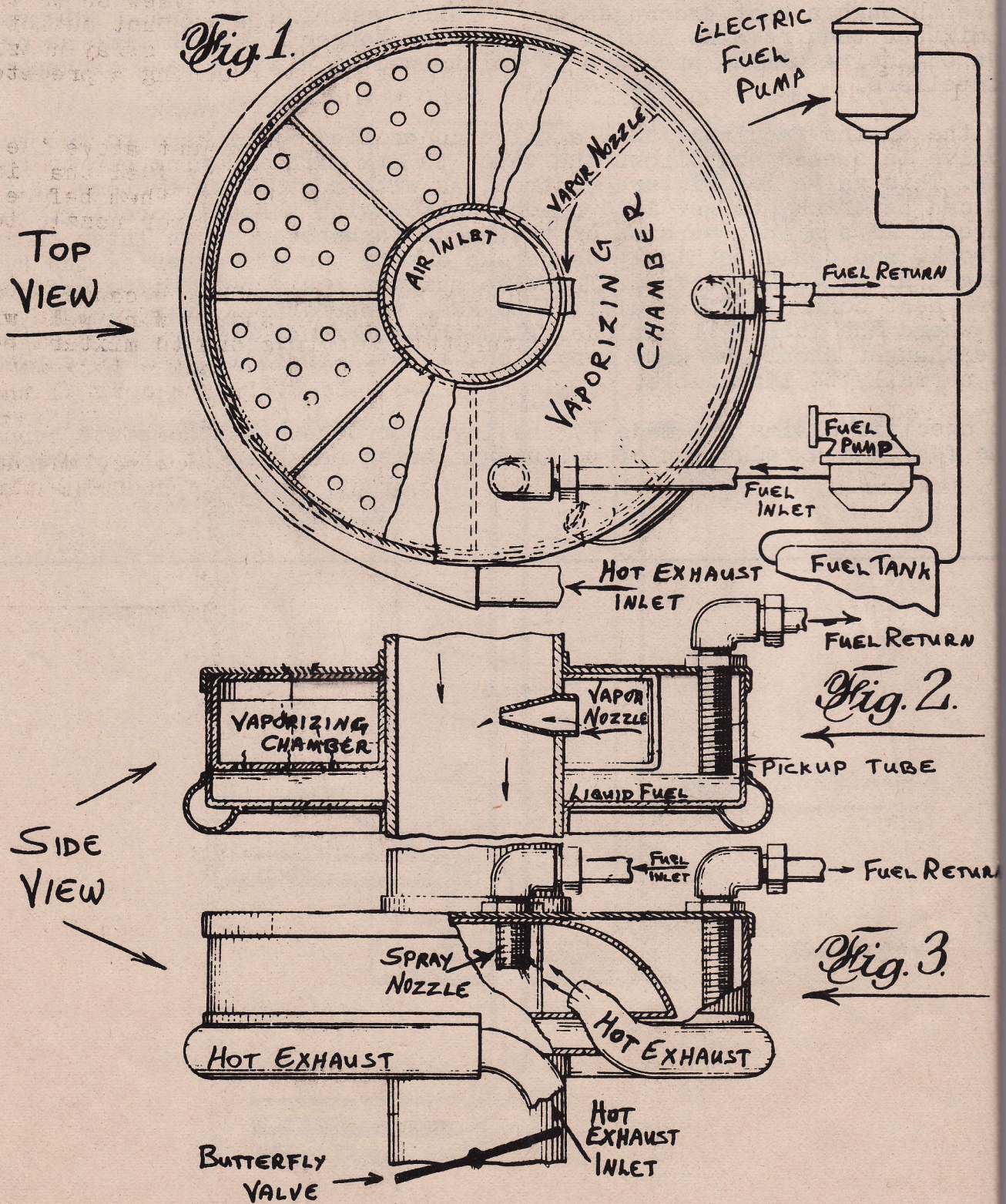

The Schwartz carburetor shown here is somewhat different than most heat exchanger type carburetors in that it allows hot exhaust gases directly in to the exchanger.

The top view shows the air inlet surrounded by a vaporizing chamber in which you will find a fuel inlet and a fuel return line, and surrounding the vaporizing chamber is the hot exhaust inlet. The side view shows the fuel inlet to a spray nozzle which is very close to the exhaust outlet into the chamber. Liquid fuel that has not been vaporized by the spray nozzle & the hot exhaust will drop into the bottom, and after reaching a predetermined level will be sucked off by the return line.

Not shown in these drawings, are a series of baffles just above the fuel level in the bottom of the chamber. These baffle catch any fuel that is not fully vaporized as the fuel exhaust mixture passes through them before getting to the air inlet. Vaporized fuel passes through the vapor nozzle to be mixed with the air for the burning process.

This carburetor should be considerably safer than most, because no air is allowed into the heat exchanger. This carburetor should work well with any engine that continually changes throttle settings due to mixture being automatic. The more the throttle is opened, the more exhaust - thus more of the fuel being vaporized upon demand. No mechanical mixture control should be required.

The inventor makes no specific claims as to mileage increase, but does claim the carburetor to be almost 100% efficient and thus producing virtually no pollutions.

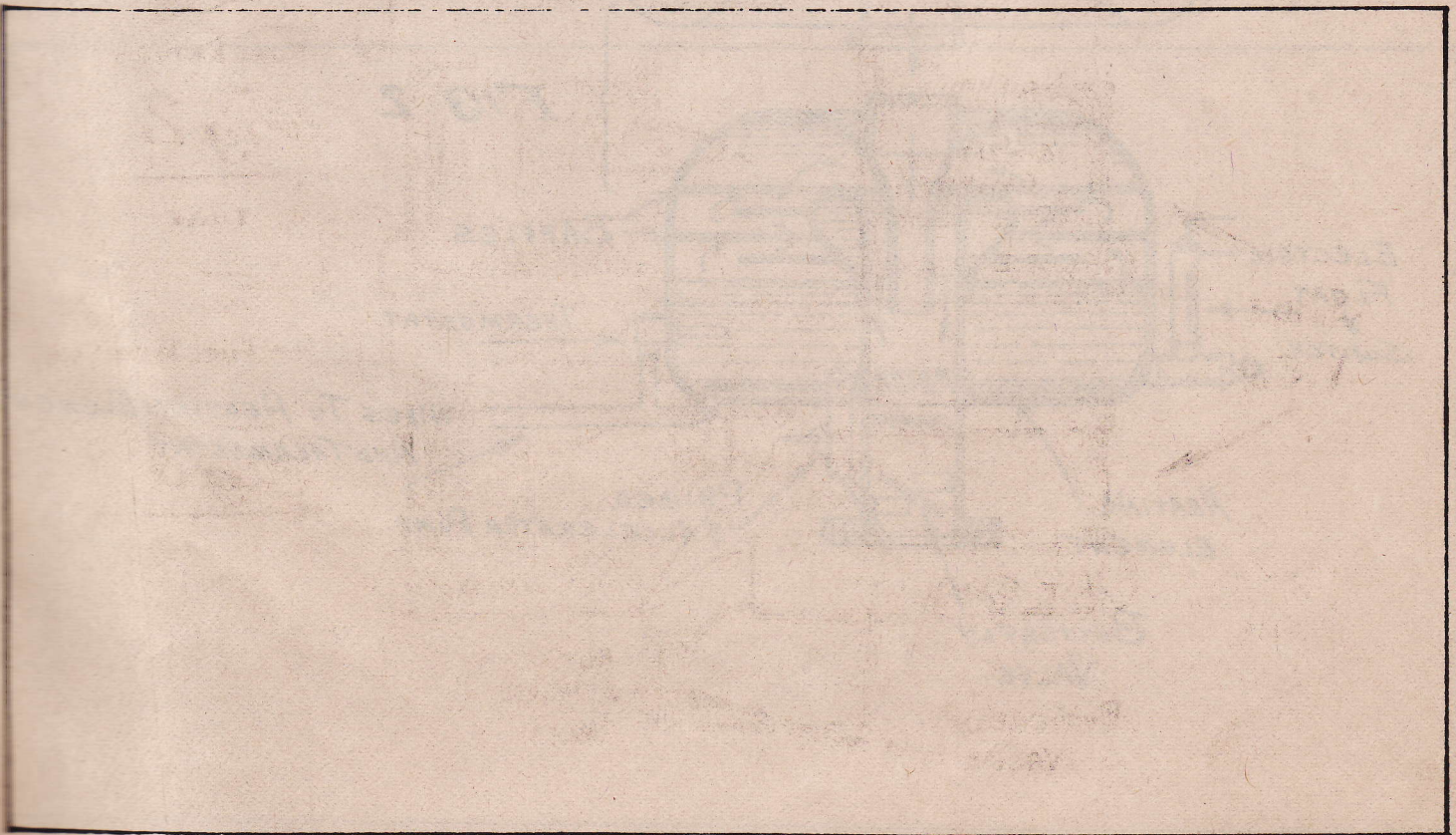

May 2, 1961

Inventor: ROBERT S SHELTON

Patent #
2,982,528

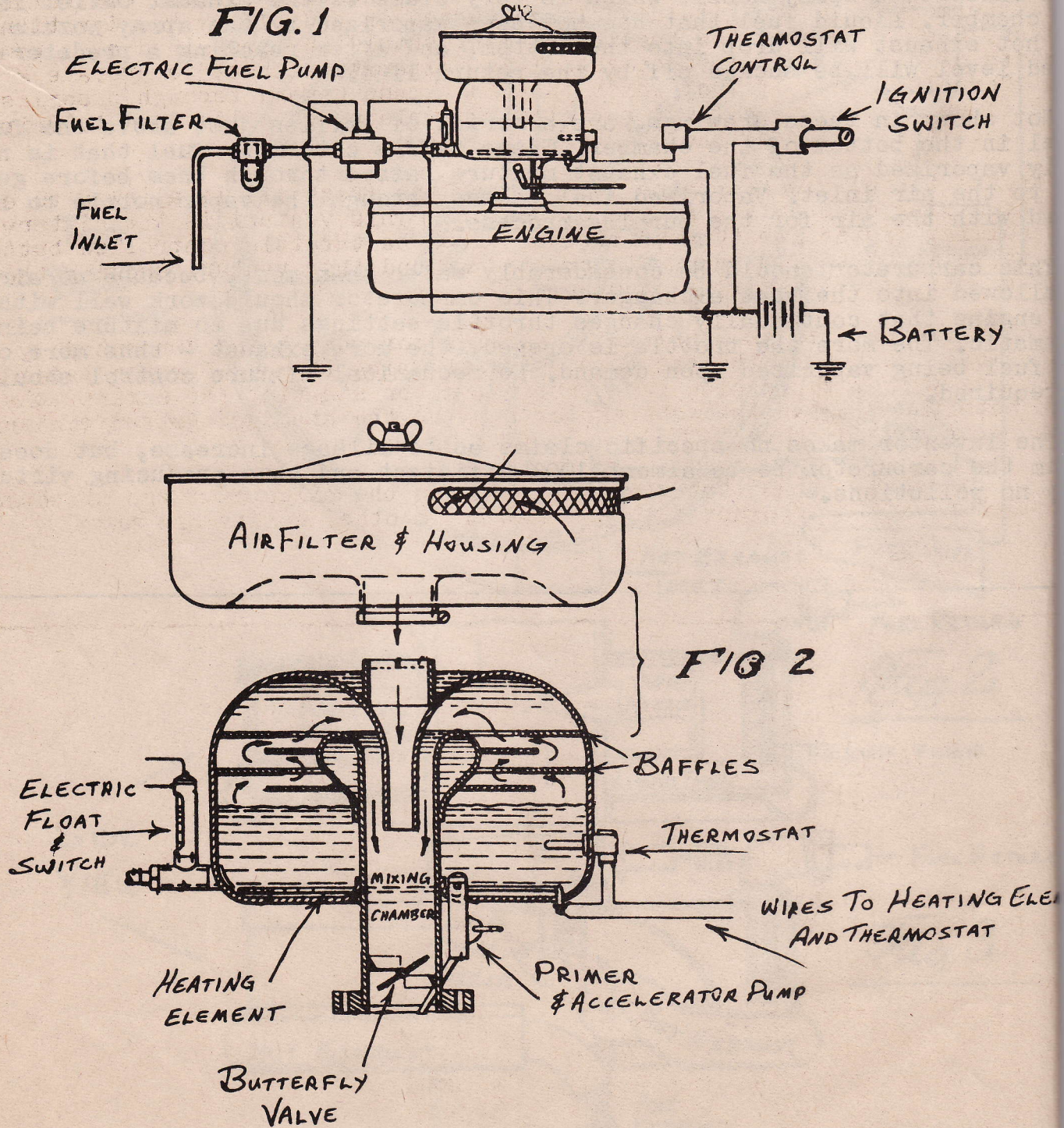

The Shelton carburetor uses both heat and vacuum to create a vapor from the gasoline. This carburetor consists of a large chamber in which a reservoir of fuel is maintained. Shelton used an electric float type switch that would shut off the electric fuel pump when the desired fuel level has been reached and to turn the pump on again when the level falls. However, any type of float arrangement would suffice.

At the bottom of the chamber is an electric heating element controlled by a thermostat in the liquid fuel and turned on and off by the ignition switch. She claims the heating element should be maintained at a temperature of 150 degrees farenheight. This temperature should evaporate a considerable amount of fuel which then must pass upward through a series of baffles which will collect any liquid droplets and allow them to drip back into the bottom of the chamber.

At the top of the evaporization chamber the fresh air is allowed to enter the mixing chamber via a type of venturi. This venturi is the mixture controlling factor for this carburetor - as the throttle controlled butterfly valve is opened, a vacuum is created around this venturi sucking the fuel vapors into the mixing chamber.

Below the chamber is a primer or accelerator pump being connected by mechanical linkage to the throttle valve. Pumping the accelerator pedal a few times primes the engine for starting, after starting the engine this pump acts the same as the accelerator pump on the standard jetted venturi carburetor you now have.

The inventor claims that up to eight times the mileage of the standard carburetor can be obtained from his model. No other claims are made.

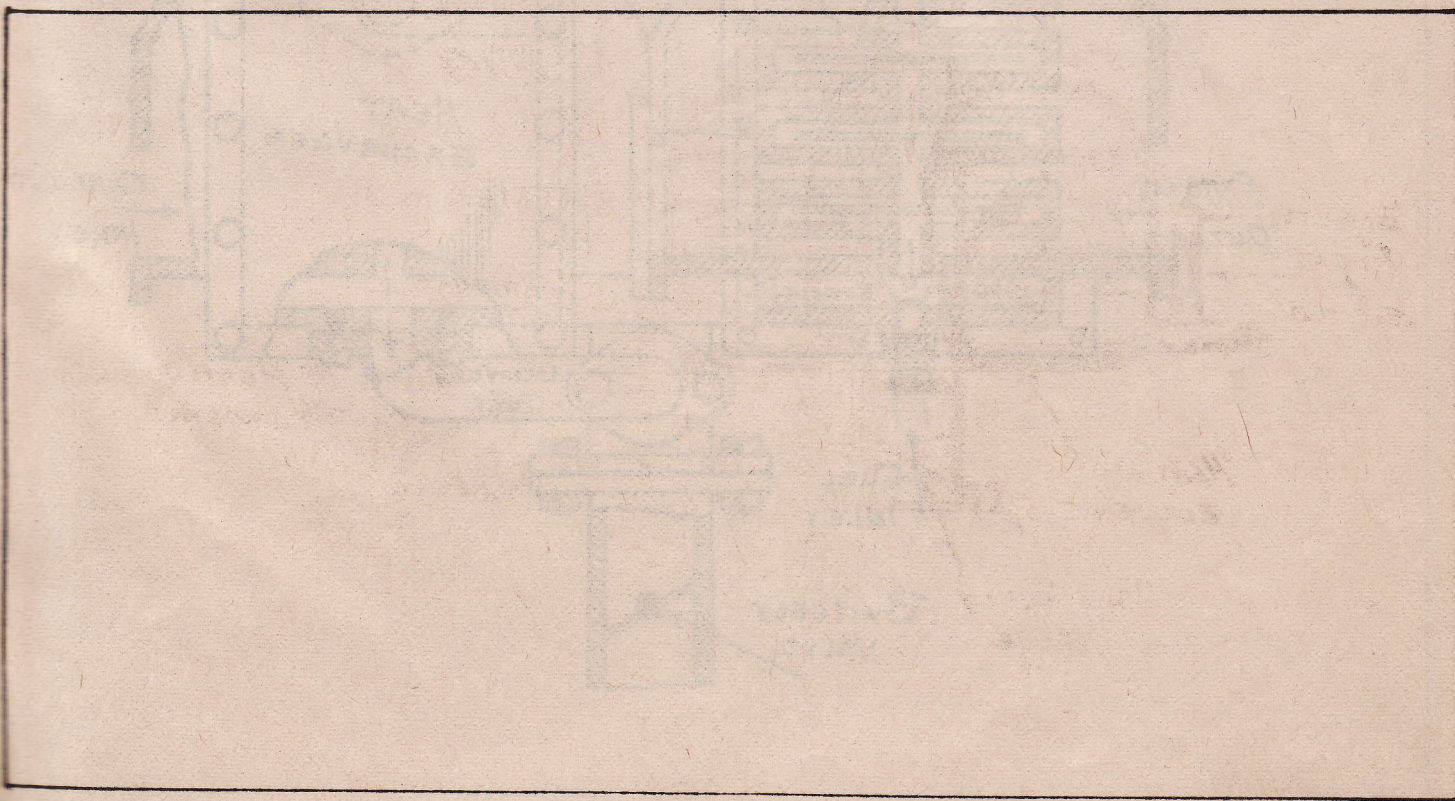

October 22, 1940

Inventor: IVOR B NEWBERY

Patent #
2,218,922

Fig. 1.

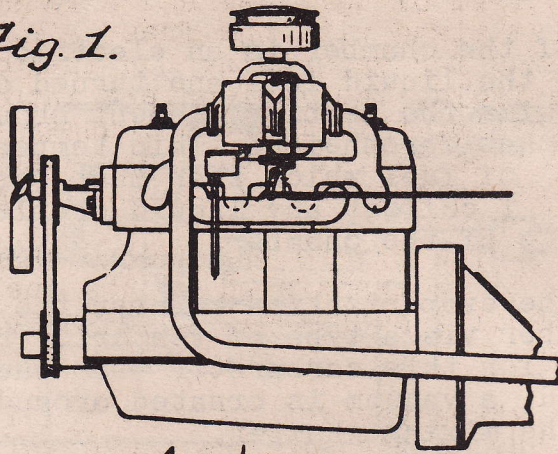
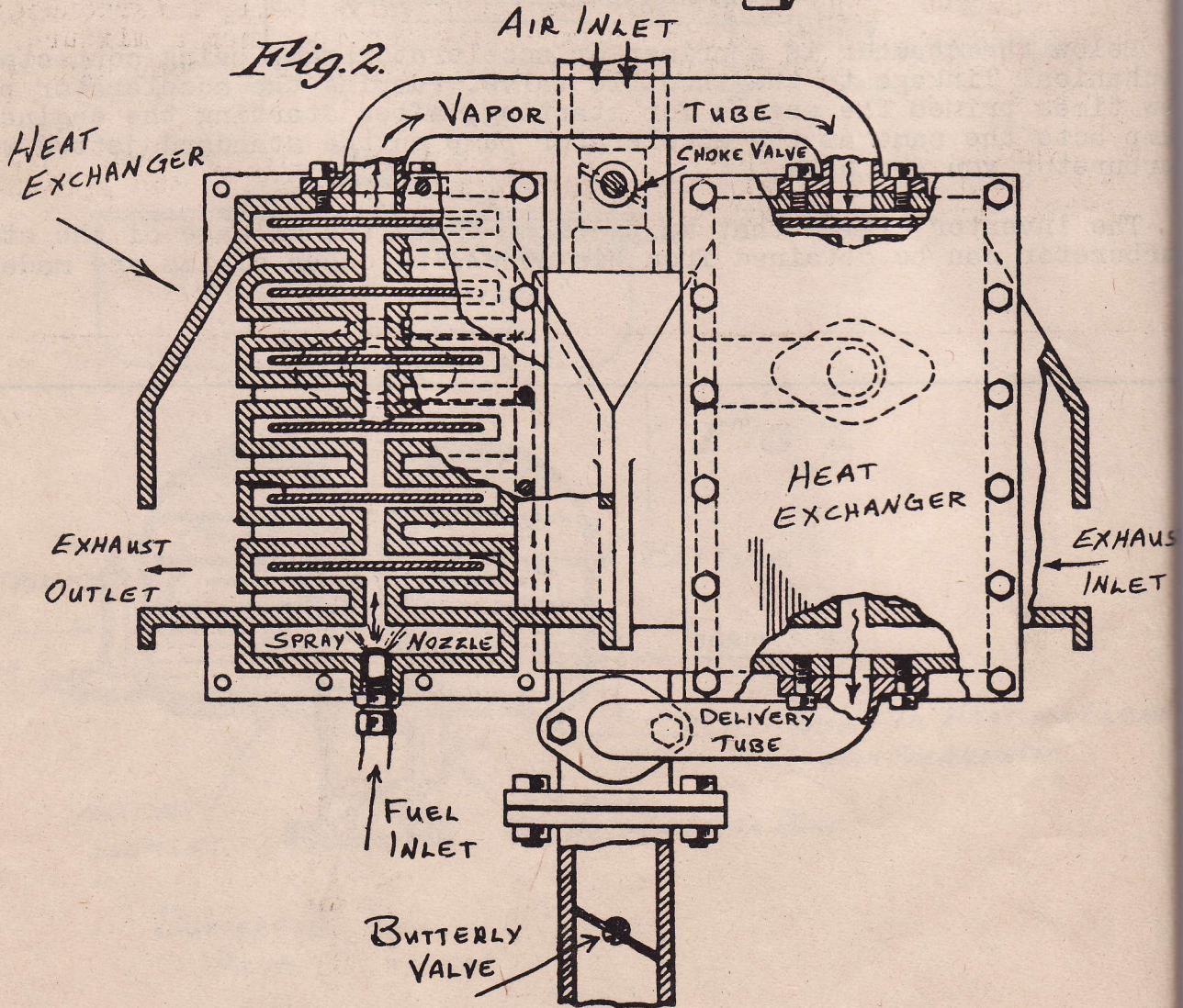

Fig. 2.



The Newbery carburetor is not really a carburetor in the normal sense of the word. Rather, it is a series of two heat exchangers that deliver a vaporized fuel to the intake manifold of the engine.

The two heat exchangers are of a type that provide a large surface of heated metal (in the form of baffles) and a rather long path for the fuel to travel before being mixed with the fresh air. This large heated area & long path are the means for vaporizing the fuel before it is mixed with the air in the intake manifold. The fuel enters into the first exchanger via a controlled spray nozzle, this first exchanger vaporizes a large portion of the fuel which is then passed into the second exchanger for further vaporizing and expansion to a true dry state.

Exhaust from the engine enters the second chamber first so as to produce a higher temperature to be transferred to the fuel just before being allowed to mix with the fresh air, supposedly to bring the already vaporized fuel to a truly dry state.

As no means for mixture control is provided I presume that the fuel is controlled by the spray nozzle and the choke valve being interconnected to the throttle so as not to allow too much air for too lean a mixture. The inventor provides no system for starting, so a primer of some kind would have to be affixed.

The inventor makes no specific claims as to efficiency other than this carburetor delivers a truly dry vapor fuel to the engine and produces very little, if any, pollutions.

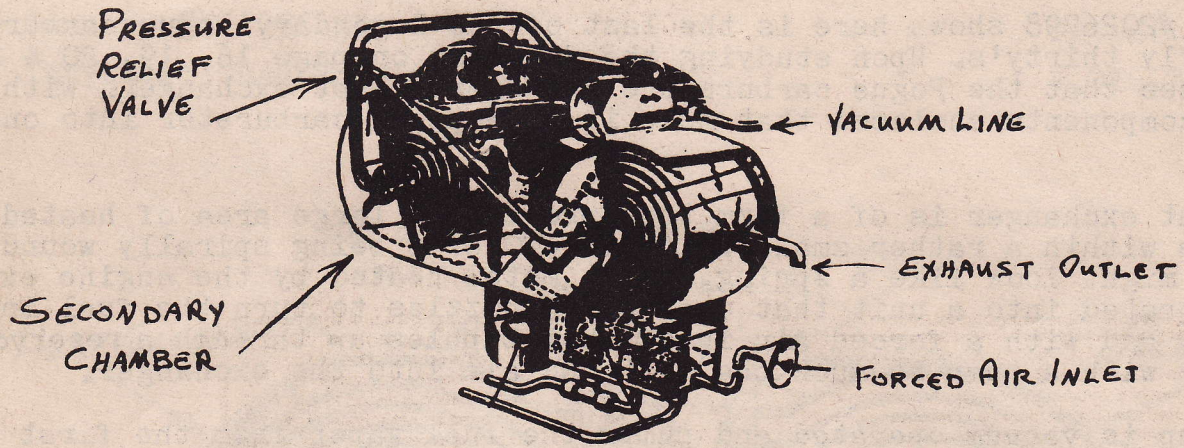

**BREEN MOTOR COMPANY LIMITED
WINNIPEG**

TO WHOM IT MAY CONCERN:

I made a test today of the Pogue Carburetor installed on a Ford eight-cylinder coupe. The speedometer showed that this car had already run over 8,000 miles.

I drove the car 26.2 miles on one pint of gasoline. The temperature was averaging around zero with a strong north wind blowing. I drove south for fifteen miles and back on the same road, and the distance as shown by the speedometer readings was 26.2 miles when the gasoline was exhausted and the car stopped.

The performance of the car was 100% in every way. I tested for acceleration, get-away from a standing start, and at all speeds, and it performed equal to, if not better, than any car with a standard carburetor.

At very slow speeds, under ten miles an hour, it was much smoother in operation than a standard car. In fact; below five miles an hour it pulled up a slight grade without laboring of any kind. I stepped on the accelerator when the speedometer was below five miles an hour and the car got away without a falter.

BREEN MOTOR COMPANY LIMITED,
(Signed) T.G. Breen, President

**FORD MOTOR COMPANY OF CANADA LIMITED
WINNIPEG BRANCH**

Mr. W. J. Holmes, 894 Wellington Crescent,
Winnipeg, Manitoba.

Winnipeg, Manitoba, April 30th, 1936

Dear Sir:

Mr. Purdy and I appreciate very much your interest in arranging test for us with Mr. Pogue.

At the time the test was made we covered 25.7 miles on one pint of gasoline.

Before starting the test, the car was run until the motor stalled for want of fuel. The pint of gas was then connected; the main supply tank was turned off, and the test started from a stalled motor.

We are at a loss to understand the reason for such marked economy. However, every consideration was shown in carrying out test and acquainting us with the design of the carburetor.

Yours truly,
(Signed) D. F. SMITH.

347 College Avenue, Winnipeg, Manitoba.

August 10th, 1936

TO WHOM IT MAY CONCERN:

I have today had the pleasure to make a test of the Pogue Carburetor. Same was installed in a Ford V-8 Coupe, 1934 model. I have taken extra precautions to turn off the speedometer to nil on the trip mileage.

I drove the car twenty-eight miles on one pint of gasoline. I tested the car for speed up to seventy-five miles per hour and as low as three miles per hour; and the car performed exceptionally nicely. In fact, I can say the performance was all anyone could desire in every shape or form.

Yours Truly,
(Signed) S. STOCKHAMMER

April 9, 1935

Inventor: CHARLES N POGUE

Patent #

1,997,497

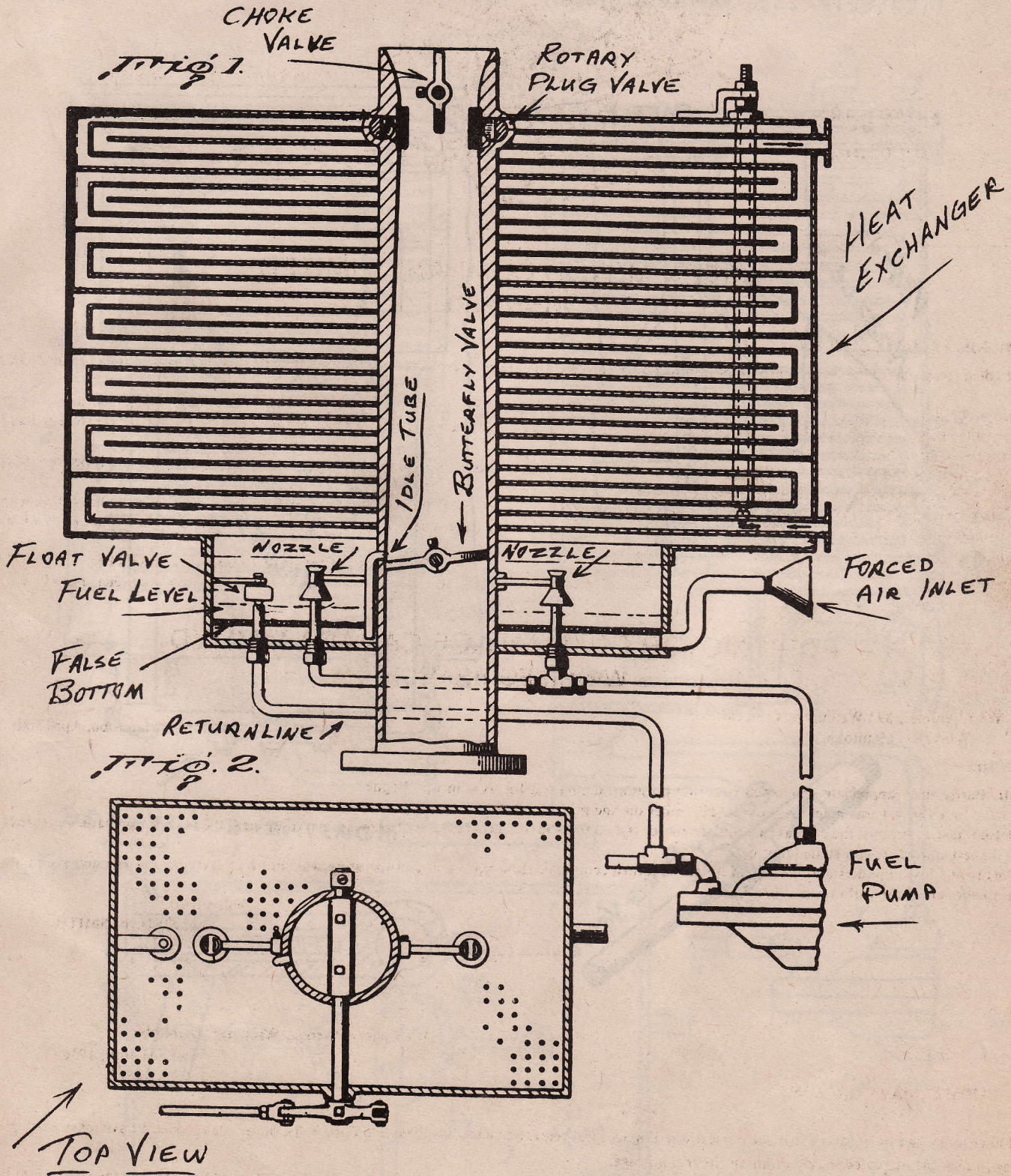

April 9, 1935

Inventor: CHARLES N POGUE

Patent #

1,997,497

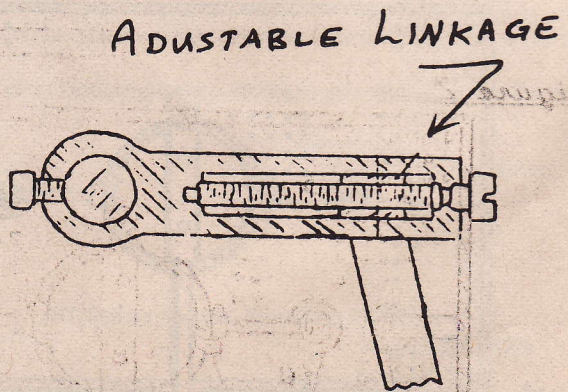
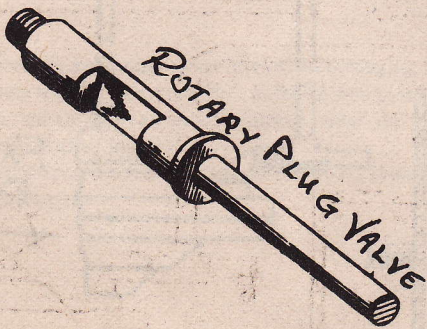
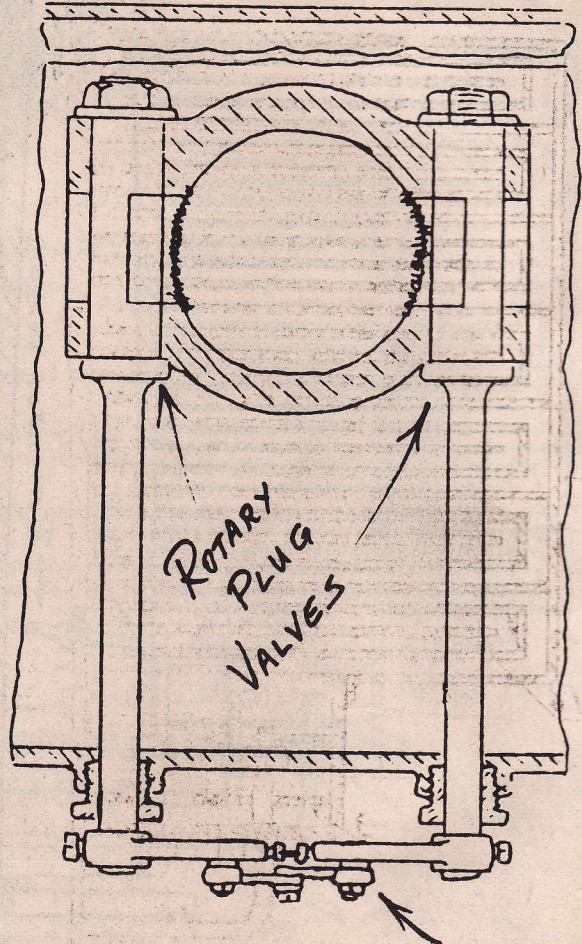
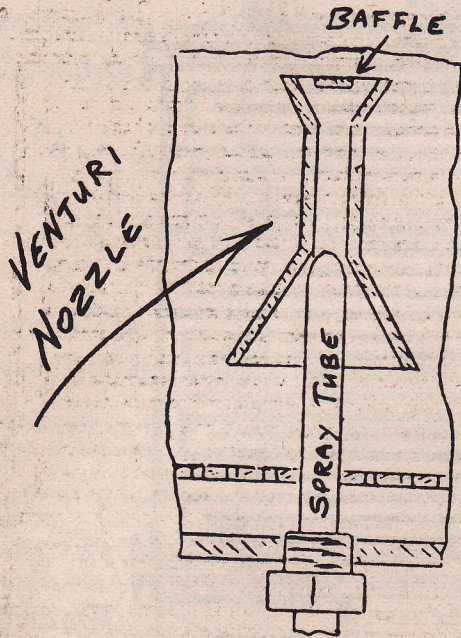

These items are identical for #2026798 except that only one rotary plug valve is used instead of two.....

January 3, 1935

Inventor: CHARLES N POGUE

Canadian #

353538

(identical to U.S. #1997497)

Figure 1

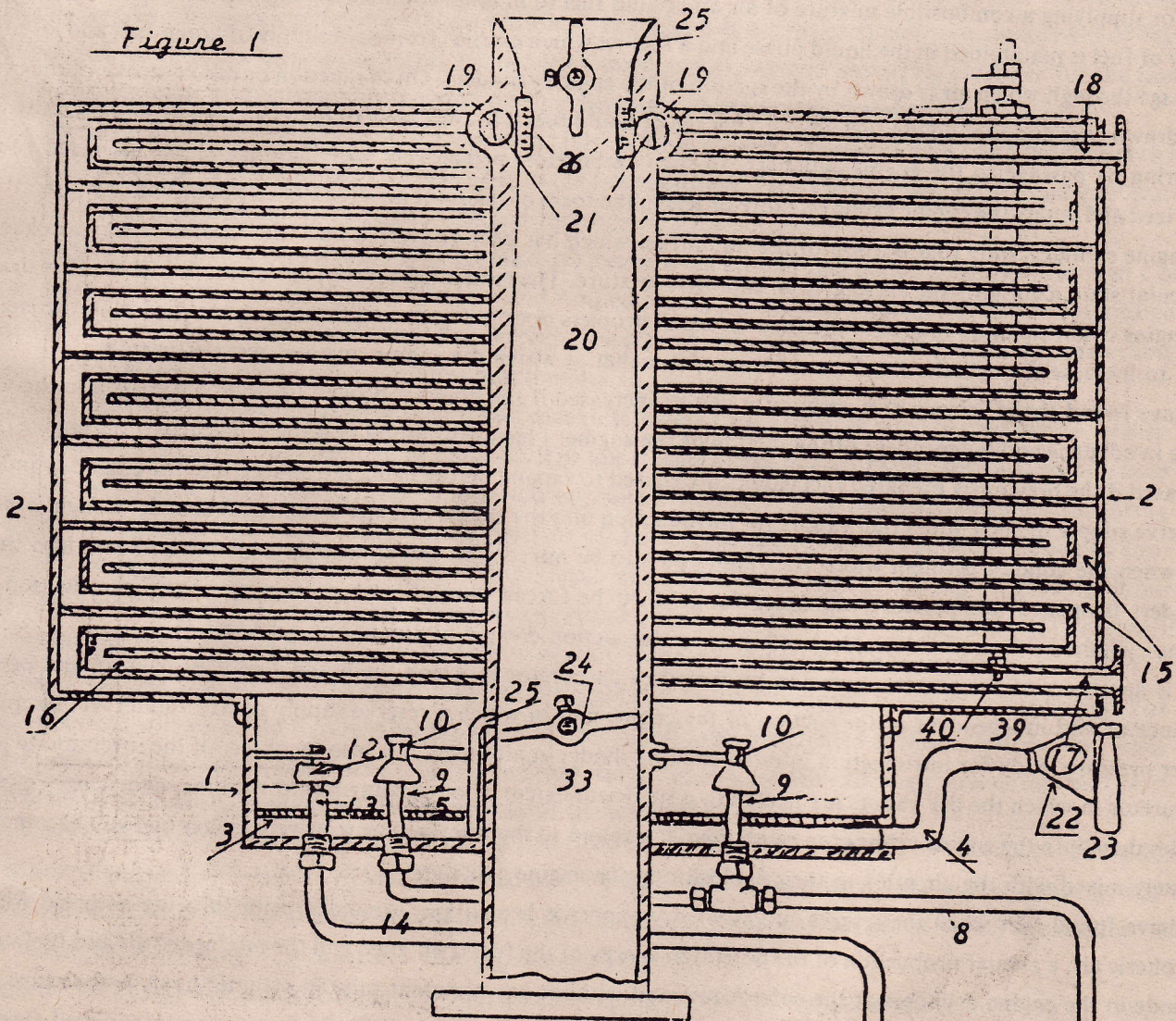
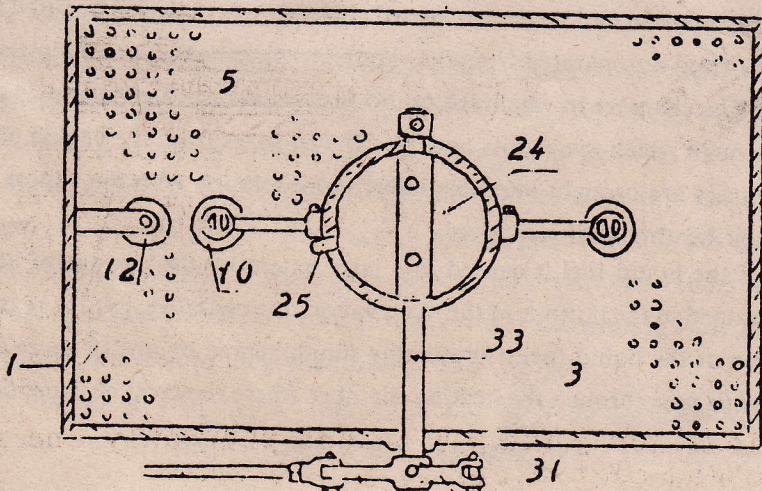

Figure 2



This invention relates to a device for obtaining intimate contact between a liquid in a truly vaporous state and a gas, and particularly to such a device which may serve as a carburetor for internal combustion engines. Carburetors as commonly used for supplying a combustible mixture of air and liquid fuel to internal combustion engines comprise a bowl in which a supply of fuel is maintained in the liquid phase and a fuel jet which extends from said supply of liquid fuel and terminates in a passage through which air is drawn by the suction of the engine cylinders. On the suction or intake stroke of the cylinders, air is drawn over and around the fuel jet and a charge of liquid fuel is drawn therefrom and broken up and partially vaporized during its passage to the engine cylinders. In such carburetors a relatively large amount of the atomized fuel is not vaporized and enters the engine cylinders more or less in the form of microscopic droplets. When such a charge is "fired" in the engine cylinder, only that portion of the liquid fuel which has been converted into the vaporous and consequently the molecular state, combines the air to give an explosive mixture. The remaining portion of the liquid fuel which is drawn into the engine cylinders and remains in the form of small droplets does not burn and thereby impart power to the engine, but tends to increase the cylinder head temperature above that at which the engine operates most efficiently.

I have found the efficiency of a carburetor can be increased if the liquid is broken up and converted into the vaporous phase in advance and independent of the suction of the engine. I have also found that the efficiency of the engine is further increased if the previously prepared fuel vapors are caused to expand before being introduced into the engine cylinder and if a reserve supply of such liquid fuel vapors for introduction into the engine cylinder is maintained under a slight pressure, so that when the conduit through which the vapors pass to be mixed with the atmospheric air being drawn into the engine cylinders is opened, the pressure will cause the gases to be forced through such passage and their introduction into the engine cylinders will not be dependent solely upon the suction created by the engine cylinders.

It is an object of the present invention to provide a carburetor in which the liquid fuel is broken up and prepared in advance of and independent of the suction of the engine and in which a reserve supply of dry vapors will be maintained under pressure ready for introduction into the engine cylinder at all times. It is also an object of the invention to provide a carburetor in which the dry vapors are heated to a sufficient extent prior to being mixed with the main supply of air which carries them into the engine cylinder to cause them to expand so that they will be relatively lighter and will become more intimately mixed with the air prior to their explosion in the engine cylinders.

I have found that when the reserve supply of dry vapors is heated and expanded prior to being admixed with the atmospheric air, a greater proportion of the potential energy of the fuel is obtained and the mixture of air and fuel vapors will explode in the engine cylinders at the correct rate and without any apparent raise in cylinder head temperature.

More particularly, the present invention comprises a carburetor in which liquid fuel vapors are passed from a main vaporizing chamber under at least a slight pressure into and through a heated chamber where they are caused to expand and in which droplets of liquid fuel are either vaporized or separated from the vapors, so that the fuel finally introduced into the engine cylinder is in a true vaporous phase. The chamber in which the liquid fuel vapors are heated and caused to expand preferably comprises a series of passages through which the vapors and the exhaust gases from the engine pass in tortuous paths and in such a manner as the exhaust gases are brought into heat interchange relation with the vapors and give up a part of their heat to the vapors to cause their heating and expansion.

The initial vaporization or atomization of the liquid fuel is caused to a large extent by the passage of atmospheric air through a constant body of liquid fuel maintained in the bottom of the main vaporizing chamber, but for reasons which will be hereinafter pointed out, such vaporization of the liquid fuel is preferably supplemented by one or more atomizing jets, but the vapors from such jets are also caused to pass through the heating chamber where they will be expanded to have any liquid droplets removed.

In the drawings, Fig. 1 is vertical cross-sectional view through a carburetor embodying my invention, Fig. 2 is a horizontal sectional view through the main vaporizing or atomizing chamber, the same being taken on line 2-2 of Fig. 1, Fig. 3 is a side elevation of the carburetor, Fig. 4 is a detail sectional view of one of the atomizing nozzles and its associated parts, Fig. 5 is a detail cross-sectional view showing the means for controlling the passage of gases from the vapor expanding chamber into the intake manifold of the engine, Fig. 6 is a perspective view of one of the valves shown in Fig. 5, Fig. 7 is a cross-sectional view showing means for adjusting the valves shown in Fig. 5 and Fig. 8 is a cross-sectional view on line 8-8 of Fig. 7 . . .

Referring now to the drawings, the numeral 1 indicates a main vaporizing and atomizing chamber for the liquid fuel located at the bottom of and communicating with a vapor heating and expanding chamber (2).

The vaporizing chamber is provided with the perforated false bottom (3) and is normally filled with liquid fuel to level X. Atmospheric air from a conduit (4) enters the space below the false bottom (3) and passes upwardly through perforations (5) in said bottom and then bubbles up through the liquid fuel vaporizing a portion of it.

Liquid fuel for maintaining the level X in the chamber (1) passes from a usual fuel tank (not shown) through a pipe (6), and is forced by a pump (7) through a pipe (8) into and through a pair of nozzles (9) having their outlets located in the chamber (1), just above the level of the liquid fuel therein. The (7) may be of any approved form but is preferably of the diaphragm type, as is normally standard on most automobiles.

The nozzles (9) are externally threaded at their lower ends to facilitate their assembly into the chamber (1) and to permit them to be removed readily should cleaning be required. The upper ends of the nozzles (9) are surrounded by venturi tubes (10) having a baffle plate (11) located at their upper ends opposite the outlets of the nozzles. The liquid fuel being forced from the ends of the nozzles (9) into the restricted portions of the venturi tubes causes a rapid circulation of the air and vapors in the chamber through the tubes (10) and brings the air and vapors into intimate contact with the liquid fuel, with the result that a portion thereof is vaporized. Unvaporized portions of the liquid fuel strikes the baffles (11) and are thereby further broken up and deflected downwardly into the upwardly flowing current of air and vapors.

The pump (7) is regulated to supply a greater amount of liquid fuel to the nozzles (9) than will be vaporized. The excess fuel that vaporized will drop into the chamber (1) and cause the liquid to be maintained at the indicated level. When the liquid fuel rises above the level, a float valve (12) will be lifted and the excess will flow through an overflow pipe (13) into a pipe (14) leading back to the pipe (6) on the intake side of the pump (7).

Such an arrangement permits large amounts of liquid fuel to be circulated by the pump (7) without more fuel being drawn from the tank than is actually vaporized and consumed in the engine. As the float valve (12) will set upon the end of the outlet pipe (13) as soon as the liquid level drops below the indicated level, there is no danger of vapors passing into the pipe (4) and hence into the pump (7) to interfere with its normal operation.

The upper end of the vaporizing chamber (1) is open and vapors formed by atmospheric air bubbling up through the liquid fuel in the bottom of the chamber and those formed as the result of the atomization at the nozzles (9) will pass into the heating and expanding chamber (2). As is clearly shown in fig. 1, the chamber (2) comprises a series of tortuous passages (5) and (16) leading from the bottom to the top. The vapors pass through the passages (15) and the hot exhaust gases pass through the passages (16), a suitable entrance (17) and exit (18) being provided for that purpose.

The vapors passing upwardly in a zigzag path through the passages (15) will be brought into heat interchange relation with the hot walls of the passages (16) for the exhaust gases. The total length of the passages (15) and (16) is such that a relatively large reserve supply of the dry vapor is always maintained in the chamber (2), and by maintaining the vapors in contact with the hot exhaust gases for a substantial period, the vapors will absorb sufficient heat from those gases to cause the vapors to expand, with the result that when they are withdrawn from the top of the chamber (2) they will be in a relatively vapor phase, and due to their expansion, relatively light.

Any minute droplets of liquid fuel entrained by the vapors in the chamber (1) will precipitate out in the lower passages (15) and flow back into the chamber (1) or else be vaporized by the heat absorbed from the hot exhaust gases in their passage through chamber (2).

The upper end of the vapor passages (15) communicates with openings (19) adjacent the upper end of the downdraft tube (20) leading to the intake manifold of the engine. Valves (21) are interposed in the openings (19) so that the passages of the vapors therethrough into the air tube may be controlled. The valves (21) preferably are of the rotary plug type and are controlled as hereinafter described.

Suitable means are provided for causing the vapors to be maintained in the chamber (2) under a pressure greater than atmospheric, so that when the valves (21) are opened the vapors will be forced into the air tube (20) independently of the suction of the engine. Such means may comprise an air pump for forcing the atmospheric air through the pipe (4) into the chamber (1) beneath the false bottom (3), but I prefer merely to provide the pipe (4) with a funnel shaped inlet end (22) and located just behind the usual fan (23) equipped on most all automobiles. That will cause the air to pass through the pipe (4) with sufficient force to maintain the desired pressure in the chamber (2) and the air being drawn through the radiator by the fan will be preheated prior to its introduction the chamber (1) and hence will vaporize greater amounts of the liquid fuel. If desired the pipe (4) may be surrounded by an electric or other heater, or exhaust gases from the engine may be passed around it to further preheat the air passing therethrough prior to its introduction into the liquid fuel in the bottom of the chamber (1). The air tube (20) is provided with a butterfly valve (24) for throttle, and a choke valve (25) as is customary with carburetors used for internal combustion engines. The upper end of the air tube (20) extends above the chamber (2) a distance sufficient to receive an air filter and/or silencer, if desired.

A low speed or idling jet (25) has its upper end communication with the passage through the air tube (20) adjacent the throttling valve (24) and its lower end extending into the liquid fuel in the bottom of the chamber (1).

The low speed jet will supply fuel to the engine when the valves are in a position such as to close the passages (19), however, the passage through the idling jet (25) is so small that under normal operations the suction thereon is not sufficient to lift the liquid fuel from the bottom of the chamber (1).

To prevent the engine from backfiring into the vapor chamber (2) the ends of the passages (19) are covered with a fine mesh screen (26) which operates on the principal of a miners lamp, and will prevent the vapors in the chamber (2) from exploding in the event of a backfire, but will not interfere substantially with the passage of the vapors from the chamber (2) into the air tube (20) when the valves (21) are in the open position. The air tube (20) preferably is in the form of a venturi with the greatest restriction being at that point where the openings (19) are located, so that when the valves (21) are opened there will be a pulling force on the vapors because of the increased velocity of the air at the restricted portion of the air tube (20) opposite the openings (19), as well as an expelling force on them due to the pressure in the chamber (2).

As shown in fig. 3, the operating mechanism for the valves (19) is so connected the operating mechanism for the throttle valve (24) that they are opened and closed simultaneously with the opening and closing of the throttle valve, so that the amount of vapor supplied to the engine will at all times be in proportion to the demands placed on the engine. To that end, each valve (19) has an extension or operating stem (27) protruding through one of the side walls of the vapor heating and expanding chamber (2). Seals or packing glands (28) of the ordinary construction surround the stems (27) where they pass through the chamber wall to prevent leakage of vapors at those points.

Operating arms (29) are rigidly secured to the outer ends of the stems (27) and extend towards each other, the arms are pivotally and adjustably connected to a pair of links (30) which at their lower ends are pivotally connected to an operating link (31) which in turn is pivotally connected to an arm (32) rigidly secured on an outer extension (33) of the stem of the throttle valve (24). The extension (33) also has rigidly secured thereto an arm (34) to which is connected an operating link (35) leading from the means for accelerating the engine.

The means for adjustably connecting the upper ends of the links (30) to the valve stems (27) of the valves (19) so that the amount of vapors delivered from the chamber (2) may be regulated to cause the most efficient operation of the particular engine to which the carburetor is attached, comprise angular slides (36) to which the upper ends of the links (30) are fastened, and which are slidably but not-rotatably mounted in guideways (37) in the arms (29). The slides (36) have threaded bores

through which screws (38) pass. The screws are rotatably mounted in the arms (29), but are held against longitudinal movement so that when they are rotated the slides (36) will be caused to move along the guideways (37) and change the relative position of the links (30) to the valve stems (27) so that a greater or less movement, and consequently a greater or lesser opening of the ports (19) will take place when the throttle valve (24) is operated.

For safety and for most efficient operation of the engine, the vapors in the chamber (2) should not be heated or expanded beyond a predetermined amount and in order to control the extent to which the vapors are heated and consequently the extent to which they are expanded, a valve (39) is located in the exhaust passage (16) adjacent the inlet (17). The valve (39) is preferably thermostatically controlled, as for example, by an expanding rod thermostat (40) which extends through the chamber (2). However, any other means may be provided for reducing the amount of hot exhaust gases entering the passages (16) when the temperature of the vapors in the chamber reaches or exceeds the optimum.

The engine has been described in detail in connection with a down-draft type of carburetor, but it is to be understood that its usefulness is not restricted to that particular type of carburetor, but could be made adaptable to the side-draft or even the up-draft type of carburetor if desired, and that the manner in which the mixture of atmospheric air and dry vapors is introduced into the engine cylinders is immaterial as far as the advantages of the engine are concerned.

The term "dry vapor" is used herein to define the physical condition of the liquid fuel vapor after the removal of all liquid droplets or mist which is frequently entrained in what is ordinarily termed a vapor.

From the foregoing description, it will be seen that the present invention provides a carburetor in which the breaking up of the liquid fuel, or total vaporization, for subsequent use in the engine is totally independent of the suction created by the engine, and that after the liquid fuel is broken up and totally vaporized it is maintained under a light pressure in a heated space for a length of time sufficient to permit all entrained liquid or mist particles to be separated or vaporized and to permit the dry vapors to expand prior to their introduction and admixture with the main volume of atmospheric air passing into the engine cylinders.

Charles N. Pogue
Inventor

Although the Pogue carburetor is a legend, it is at the same time somewhat of a phantom. In the past 45 years no one has ever placed it on the market, and many people have successfully built working models of the Pogue carburetor. Working models of the phantom are so rare that no one ever seems to be able to track one down and actually see it in operation. As of the first of this year though, we have been in contact with one man who has a working model of his own manufacture.

Several magazine articles have been printed about the Pogue carburetor & about the man himself. One such article from the Dec 12, 1936 issue of the Canadian Automotive Industries states that the average imperial gallon of gasoline contains about 140,000 ETU of energy. And that the average American sedan takes 75 ft/lbs of torque to keep it moving at a steady 20 miles per hour. Using these figures and a 25 mpg figure they show in a formula that this only a 9% efficiency - Therefore if the Pogue carburetor delivers 200 miles to the gallon, over-all efficiency is raised to 72%

An article from the September 1953 issue of Cars magazine states that in the opening months of 1936, Pogue panicked the Toronto stock exchange and threw a fright into the major oil companies. Stock exchange offices & brokers were swamped with orders to dump all oil stock immediately. This same article refers to a manager of one of Winnipeg's largest automobile dealers who claims to have made a test of the Pogue carburetor and had driven 216.8 miles on one imperial gallon of gasoline. The same article presents what is supposed to be a personal interview with Charles Pogue, and describes him as a resigned old man who accepts the past and keeps his secrets to himself. Sitting behind a battered old wooden desk he runs a tired old machine shop making oil filters.

In this interview Pogue will not make specific claims as to performance of his carburetor, nor will he deny the claims of others. The article says that Pogue admits to having been threatened and to having his workshop broken into with unfinished carburetors being stolen - but that he was not bought off. Pogue says that he lost \$100,000 and his partner lost \$100,000 trying to get the carburetor into production - and he still has \$20,000 worth of dies laying in the back room.

Sometime later an article from Our Sun describes Pogue as a typical well dressed business man, successful and with a keen mind and a glint of enthusiasm in his eye. He runs his own business called Economy Carburetor Co., although he produces oil filters and not carburetors. The article states that Pogue is somewhat bitter about the treatment he gets from reporters & that they usually write what they want instead of the facts. Pogue used one of his carburetors on his own car for about ten years and that about 200 of that same model had been produced.

Note that none of the articles state that Mr Pogue himself makes claims of 200 mpg, and as far as we can find - Pogue never did make such a claim, nor did he state any particular mileage figure for his carburetor. We have heard that the carburetor was as big as the engine itself and that it was dangerous to operate, but Pogue denies these statements. Most magazine articles about this man and his carburetor seem to contradict each other in various statements so I'm not so sure most of it is pure legend or pure fiction. However the carburetor, phantom as it is, is real and it does do a very good job of using up most of the energy in a gallon of gasoline instead of dumping it out the exhaust.....

The phantom carburetor of Charles Pogue has disappeared from the public eye, and re-appeared many times over the past 45 years. Every few years some rumors and stories begin to circulate about some one trying to manufacture & market the carburetor, but for some unknown reason - the stories die out and the carburetor never makes it to market. Many people have built the Pogue & some have been very successful. We have a letter in our files from a Mr Gail ye of Benton, IL who claims that he has been offered a \$100,000 a year job to quit playing around with these things. Another letter from a Bill Stewart of Nestor, CA says that he and a partner built a Pogue about 25 years ago - but after having some problems with it and no money to continue working on it, Shelved the project and never got back to it.

But now the phantom is no longer a phantom - after 45 years the ghost is returning to life. A Mr Arthur C Sgrignoli has built a rough hand made model of the Pogue that has increased efficiency by 86%. Contact was made through his brother - William J Sgrignoli of 18 Riverview in Enola, PA 17025 and we obtained the following photographs:

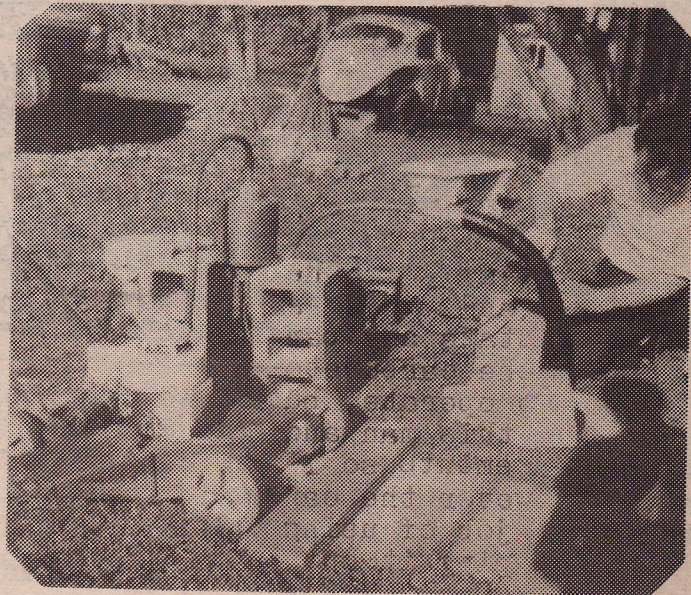
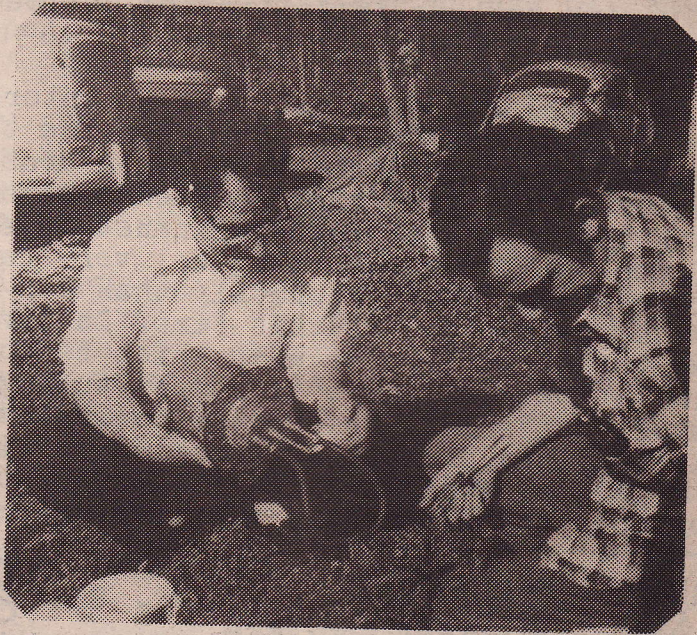
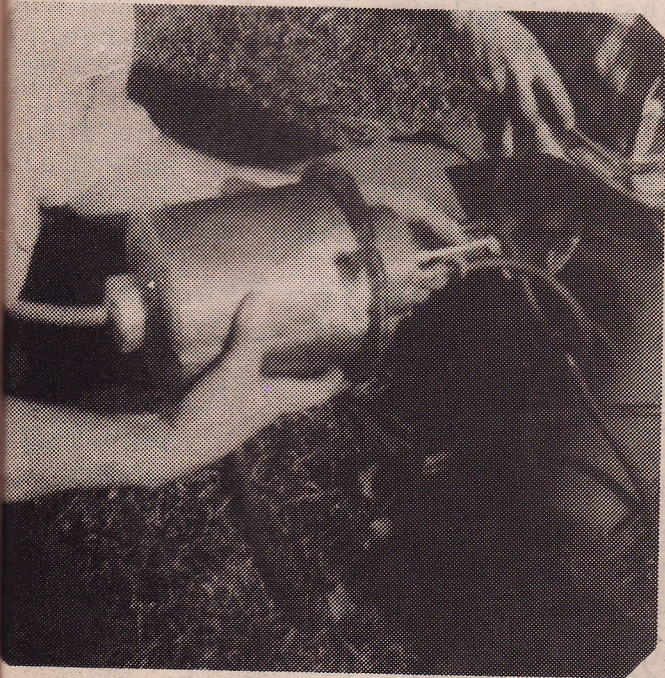

The model shown in the photographs is all hand built of copper, the upper chamber is 6 inches high and 6 inches in diameter - the lower chamber is 1 & 3/4 inches high and 4 inches in diameter - the vapors are drawn from the top instead of down through a central air inlet tube. Using a hair dryer for the heat source, Mr Sgrignoli ran the lawn mower engine for 13 minutes on four ounces of gasoline as opposed to the 7 minutes on four ounces with the standard carburetor representing an increase of 86% in fuel efficiency. As of late last year Mr Sgrignoli was working on a side draft model to be installed on his pickup truck. If left alone to work on it, we have no doubt that he will be successful.

A man in Richardson, TX is selling plans to a carburetor modeled after the Pogue but used in conjunction with the standard carburetor for starting and cold running. An automatic thermostat switches over to the Pogue type carburetor when temperature is hot enough to vaporize the fuel. His model is much the same dimensions as that of Mr Sgrignoli - upper chamber is 5 inches high and 7 inches diameter, lower chamber is 2 inches deep and 4 inches diameter. He claims to have installed the device on a Lincoln and has obtained up to 100 miles per gallon.

Many thousands of backyard inventors have come up with systems that get a much better efficiency from gasoline than does the modern carburetor, and a few have built systems that get a drastic increase. The Pogue is the most famous of all, yet there are easier ways to vaporize fuel and control mixture than those used by Pogue. Exhaust injected directly into the flow of a mist of fuel will vaporize the fuel very rapidly, and a venturi can control the mixture much more accurately than can mechanical valves. We are working on a system of our own at this time. In our experiments we are using a standard two barrel carburetor with which to control mixture thru the venturi's. We have run several turns of copper tubing around the exhaust pipe to partially vaporize the fuel before the venturi suck it into the air stream. The fuel & air are then drawn thru a series of filters of a highly absorbent material. The filters catch any fuel that is not fully vaporized and absorb it onto a surface that allows the air passing thru to rapidly evaporate the liquid...

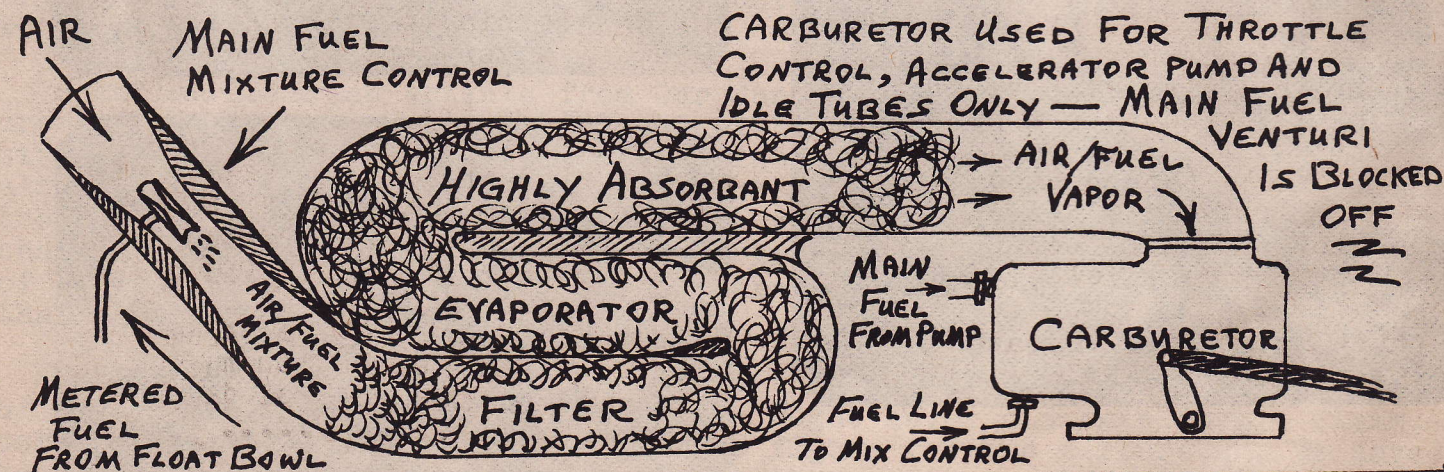

The device looks so good we are looking forward to a range of 30 mpg and better from a heavy American car with automatic transmission and V-8 engine. How about you? Can you build one? If not, how about a friend or relative that is a shade tree mechanic? Some day we all might have something better, but for now - if you want it, ya gotta build it yourself.

Good Luck / Allan Wallace dba RoadRunner Publications
Raymondville, TX 78580

.....1981 Update.....

The FLEX GAS VAPORIZOR developed by ONMEWTRONICS of Carson City, NV was being distributed by: Van M Polowchak - 111 Pine - Fort Morgan, Colorado 80701 -/- Recent inquiries have gone un-answered.....

The man who claimed to have built a Pogue type carb to run in conjunction with the standard carburetor was doing business as: FUELMIZER Box 6025 - Richardson, TX 75080 -/- Recent inquiries go un-answered.

Have heard from sources in El Paso that TOM OGLE sold out to ADVANCE FUEL SYSTEMS of Seattle, Washington for \$250,000.00 - while still retaining 20 % interest in his device that got 100 MPG on a 1970 Ford..

As of January 81 - CHARLES NELSON POGUE is still alive at age 81, and is living in a rest home in Winnepeg, Canada. He refuses to talk to anyone or to receive visitors from outside his own family.....

The world record for high mileage now stands at an incredible 1,368 miles per gallon - obtained at the Shell Motor Mileage Marathon in Great Britain. A special built three-wheeler with a 90cc engine made the run using the sprint & coast method of driving.....

The system shown on page 28 of this book has been revised to use a complete carburetor (less butterfly valve) at the point of air entry instead of the hand built venturi shown. The original carburetor is used for the throttle butterfly valve only and the added carburetor supplies all fuel to the engine via the evaporator filter system. A few problems are still popping up, but have obtained 30 MPG on a 50-55 mph run of 60 miles. Still experimental though and not yet available for general use.....

ULTRA-LEAN CARBURETORS of Northridge, California is selling a set of plans for a Pogue carburetor for \$50.00 - A very high price for info that you already have from this book, Except they give you dimensions for a device that they claim will work, but we tried it - and it don't.

Literally thousands of gadgets have come upon the market lately that are supposed to increase your gas mileage. From COW MAGNETS to VAPORIZING SCREENS, but be careful about wasting your money on these dumb things - very few (if any) really work any better than a good tune-up.

Need more info on patents? Complete patents are available from the U.S. PATENT OFFICE - WASHINGTON, DC 20231 at 50¢ each. You must tell them the patent number, the inventors name and the date of issue and they take about 90 days to get your order to you.....

BEST OF LUCK TO ALL YOU TINKERERS OUT THERE.....

Allan Wallace

Take the BITE out of Fossil Fuel Costs

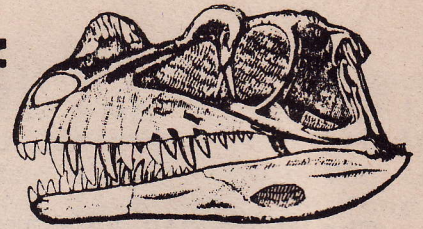

Heat Your Home and Run Your Car on ETHANOL that You Can Make for as little as 10¢-A-GALLON!

Here is the first practical solution to the high cost of energy—your own, continuous, unlimited source of pure, ethanol alcohol fuel that you can make in your own backyard for just pennies per gallon.

Unlike the complicated vaporizing carburetors that only technicians understand and have yet to be placed in common, everyday use, thousands of Americans are meeting their own energy needs with ethanol right now. In 1981 alone, nearly 50,000 Americans applied for the simple, Federal "experimental" permit necessary to distill fuel at home. There is no need to wait for government or industry to change course. You can cut your energy costs by 95% TODAY!

"IT'S LIKE OWNING A CAR THAT GETS 300 MILES PER GALLON!"

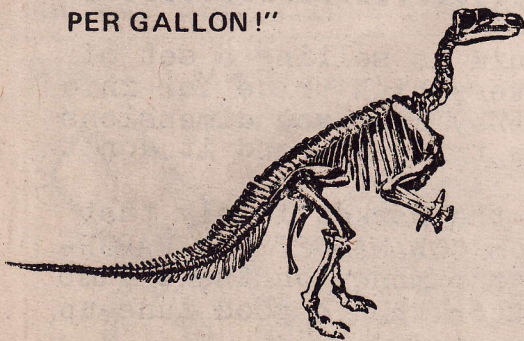

BACKYARD ENERGY PLANT FOR \$40.00!

You don't have to be a chemist to distill your own fuel at home. You can build a complete distillation plant with ordinary household tools in as little as two hours...for about \$40.00. No special mechanical ability is required. It's remarkably simple.

The SOLAR-POWERED STILL
Once your energy plant is finished,

it costs nothing to run...because it will be powered by the sun. With no other auxiliary energy source you can produce 140-180 proof ethanol. Best of all, it comes from your solar still ready for use in your car, truck, boat, lawn mower, or oil-fired furnace!

FUEL OF THE FUTURE

Ethanol is superior to the fossil fuels now in use. It burns cooler and cleaner than petroleum distillates with no carbon buildup. So, your engine or furnace will have a longer life. And the environment is not polluted with the lead and other harmful additives found in conventional fuels. In the nation of Brazil, all new cars are made to run only on ethanol...and vast quantities of it are distilled from bumper crops of Brazilian sugar cane. But, the Brazil model is far from unique because, ethanol can be distilled from almost anything that grows. Corn, sugar beets, wheat and many varieties of fruit produce particularly fine grades of ethanol.

PLANT AN ENERGY GARDEN

By growing your own corn or sugar beets, the cost of producing your own fuel can be next to nothing. But, there is no need to wait for a garden to grow or for enough space to raise the fruits or grains you need. You can purchase what you need from a local feed store or mill and still enjoy phenomenal savings. Organize a co-op with neighbors and you can begin enjoying impressive production levels with a minimum of personal effort.

"INSTANT ETHANOL"

Begin receiving the benefits of ethanol fuel now. The complete "INSTANT ETHANOL" Manual will provide you with all the step-

by-step information you need to:

- Obtain a Federal Distillation Permit
- Construct Your Own Solar Still from Inexpensive Materials Using Household Tools
- Make the Easy Modifications That Allow Your Car and Furnace to Run on Ethanol

Everything you need to know to get started now is contained in this exciting manual. And, the cost of "INSTANT ETHANOL" is just \$14.95.

MONEY-BACK GUARANTEE

You must be completely satisfied with your manual, and convinced that you can make your own fuel inexpensively, or you may return it in resalable condition within 30 days for a full refund. We are confident that you will find that learning to produce your own fuel from free solar energy can be one of the best and most exciting investment of your life. And, it's all yours for less than the cost of a tank of gasoline. Send for a copy right now and discover the thrill of energy independence plus hundreds of dollars a year in extra spendable income.

YES! I want the fuel cost savings and energy independence offered by "INSTANT ETHANOL".
Rush me a copy at once by return mail. Enclosed is \$14.95. Thanks.

NAME _____

ADDRESS _____

CITY _____

STATE _____

ZIP _____

Book No. 233 \$14.95

JUST RELEASED! Order from the address on the back cover.

1982 UPDATE
" SECRETS OF THE 200 MPG CARBURETOR "

Supercedes All Previous Updates and Revisions

..... COPYRIGHT 1982 ALLAN WALLACE

Over the past year and a half we have had many questions for further information regarding these high mileage carburetors and some of the statements we have made in our original book. Hopefully this "update of information" will be of some help to our readers and answer most the your questions ...

.....
In the text for the Pogue carburetor beginning on page 22, a few readers have noted that reference is made to figures three and eight and that these figures do not appear in the book anywhere. We wish to appologize for our inadvertantly leaving these out and have placed the full page from our files containing these figures on the back side of this sheet you are reading now.

Many have asked for further info on the FLEX GAS VAPORIZOR and we have reproduced the information we have in our files beginning on page three of this update. Van M Polowchak was a distributor for the system at one time but mail to this man has gone unanswered for some time now, however one of our readers phoned us to say that he talked to Mr Polowchak by phone and that Mr Polowchak had said that you had better not fool around with these things cause the government will get you???? We leave it up to you to decide for yourself what he may have meant by that statement.

The man from Richardson, Texas has been asked about many times and since we can no longer get a response from him - we have reproduced the information we recieved from him starting on page six of this new update. We never could get his name, but he was selling the info by mail under the name of FUELMIZER.

TOM OGLE the man in El Paso who got 100 mpg from his 1970 Ford has past away. Our sources in El Paso told us he died August 18, 1981 and rumor has it that he died of an overdose. Some time ago Tom Ogle sold an interest in his system to ADVANCE FUEL SYSTEMS - 610 Industry Drive - Seattle, WA 206-575-1594 & 206-575-3835. Last we heard, they now claim that they could not make Ogle's system work. However, we heard some rumors that they were at one time trying to sell the prototypes that they had made at about \$800 each. They are now selling a system that we heard was of a manifold or throttle body injection type and it only increases mileage by about 30%. they also want \$800 to \$900 for the unit installed on your car.

Figure 3

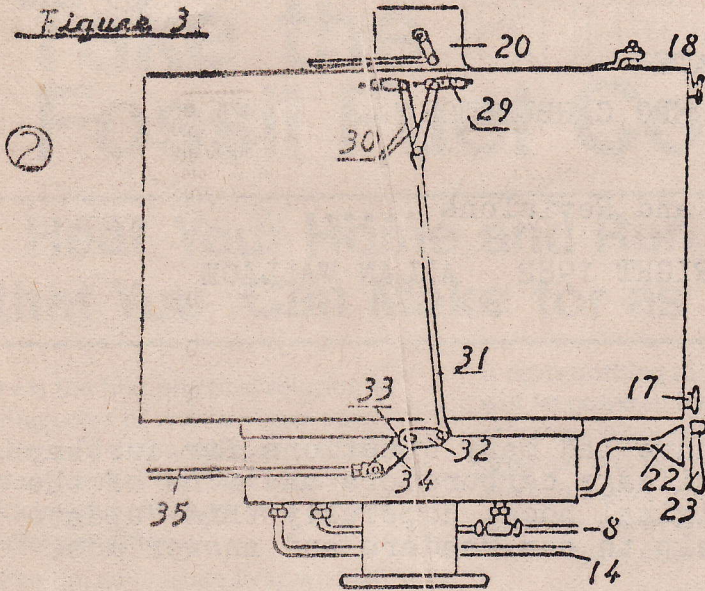

Figure 5

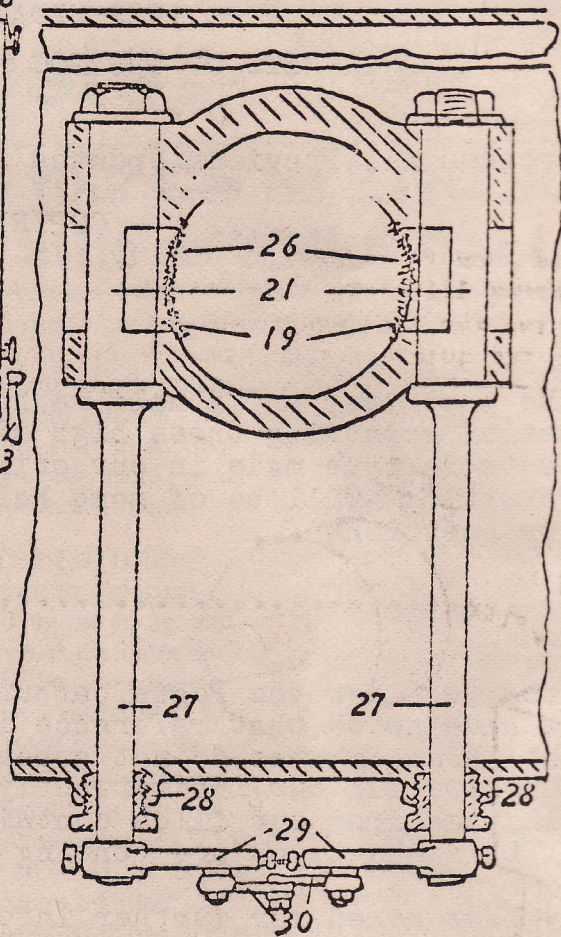

Figure 4

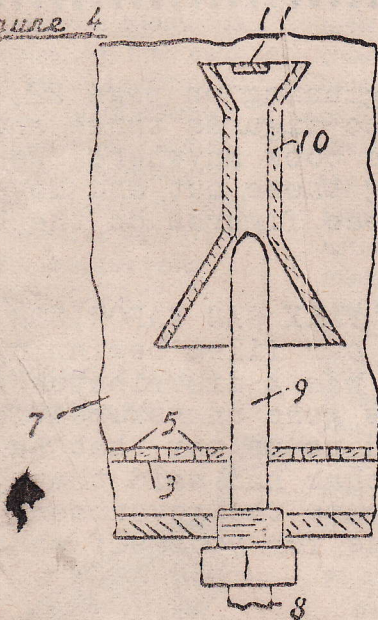

Figure 7

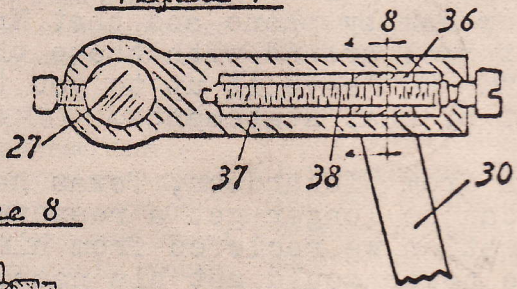

Figure 8

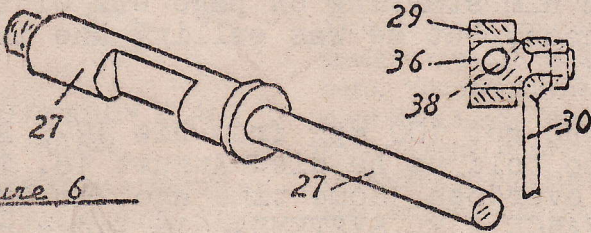

Figure 6

Carburetor 353538

Ottawa, January 3rd

1935

INVENTOR
Charles N. Pogue
by

FILEX

DOUBLE YOUR GAS MILEAGE,
guaranteed or your money back. Gas
vaporizer. Imagine gas 100 40, Econ-
omy 100 mpg. V. Polowchuk, 111 Pine
Ft. Morgan, CO 80701 (303) 867-7586

3

THIS PAGE IS FROM FLYER SENT BY
VAN M. POLOWCHAK 111 PINE, FT. MORGAN, CO.
80701. ADVISING PRE SALE DEALERSHIPS AT
\$559.50...LATER QUIRYS GOT NO REPLY

SATISFACTION GUARANTEED
Regional Director Bill Green gets
110 MPG on 72 DATSUN
62 MPG on 77 LINCOLN C.

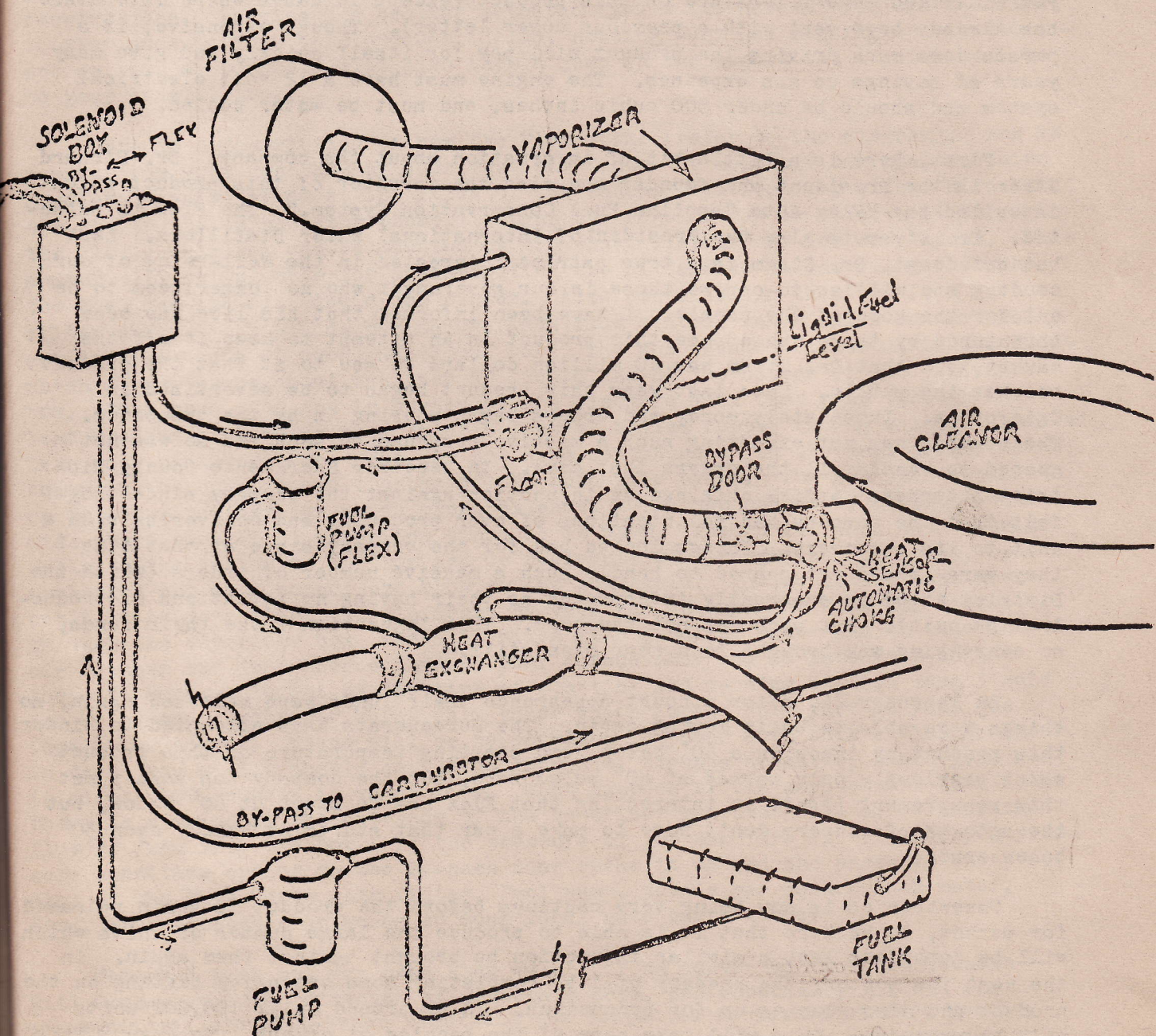

④

Date:

4/14/78

Dear Sir:

Thank you for your interest in the Flex gas vaporizer. Onmewtronics of Carson City, Nevada, has developed a product that increases the efficiency of your vehicle greatly. A typical carburetor injects only liquid droplets of gas into your engine. Only the part of those drops which turns to vapor in your engine (roughly 25%) burns, thus the carburetor system is very inefficient. This incomplete burning results in pollution and carbon buildup in your engine. Flex corrects this inefficiency by turning all of your gas into vapor before it enters the engine. Thus you get the use of nearly 100% of your gas, pollution is virtually eliminated, and carbon buildup is largely eliminated. Enclosed you will find some literature on this product (except in cases where literature has already been sent with a previous cover letter). Though expensive, if a person does much driving the product will pay for itself quickly and give many years of savings on gas expenses. The engine must have a 12 volt electrical system and should be under 500 cubic inches, and must be water cooled.

First, here is a little bit of information about the company. Dr. Richard Strem is the President and founder and also the inventor of this product which is called the "Flex Auto Gasoline Fuel Conservation System." The Flex is patented. Dr. Strem is also the President of International Water Distillers. Last but not least, Dr. Strem is a true patriot interested in the well-being of our country and willing to oppose those in our government who no longer seem to be out for the good of the people. I have been informed that his life has been threatened by those who oppose this product in an attempt to keep it off the market, but that Dr. Strem has 40 million dollars to see to it that the product reaches the public. Late last year this product began to be advertised in California. Immediately money and orders began pouring in by the thousands. The company was not expecting such a massive response so soon and so was not geared to handle all the orders that came. In December Sacramento County District Attorneys' office obtained an injunction against the company since they felt that the company had no intentions of ever producing and delivering such a unit to its customers. Things looked bad for the company since at that time they were indeed not geared to handle such a massive number of orders (which the District Attorney apparently interpreted as their having no intentions of producing the unit). But such was not the case. This Injunction froze their funds, so everything was brought to a near standstill.

On February 24, after a court appearance their funds were released again, so things were able to begin moving again. The Bureaucrats have attempted to hinder this product by imposing a 60° below zero starting temperature on this product which previously only worked at 40° below zero, but the company has easily met this requirement (Isn't it interesting that Flex has to start at 60° below, but the auto manufacturers don't have to make a car that starts at hardly even 30° below zero).

Onmewtronics is now being very cautious before the product is again released for market, to be sure that it is able to produce the large number of units which will be demanded, lest a similar injunction be brought against them again. In the next few months, the company will be completing some extensive testing on the product and also gearing up for production. In or around July, 100,000 units will be produced. This will take care of the backlog of orders. By August it is felt that one million units will be produced. After that, millions of units

to becoming a dealer now is that competition is nil. I feel that once the product is released on the market and the public sees it in action there will be a massive demand for the product and dealers everywhere will be signing up many other dealers everywhere to meet this demand and much competition will arise. A dealer who has already built his organization of dealers will be all ready to go and sell immediately at the time of this massive demand before many other dealers bring competition. This massive public demand may be fulfilled within 6 months to one year after the product comes to market, after which sales will taper off. So you can see that due to the shortness and explosiveness of the period of large sales, the one who gets into the market first has by far the most chance to make the money of a lifetime.

Having a unit yourself will be the greatest single factor for effective selling. If you sign up now you will receive your unit before over 99% of the country does. Imagine the selling potential you will have if you are the first in your area to have this product. Also, getting busy and signing up other dealers as soon as possible will give them a jump on the market too - which will be to your benefit too.

Here is a description of how the Flex works (refer to the diagram). Gas is pumped from your gas tank by your fuel pump into the solenoid box that contains a solenoid valve which at the flick of the manual switch on top either directs the gas to the carburetor where it burns the regular way or directs it through the Flex. This box can be mounted on the panel of your car for easy reach. This switch will be valuable for demonstrating the difference in gas mileage between the Flex and the old liquid gas system. Also contained in this box is a fuel filter and a 0 - 5 pounds per square inch flow control valve which can be easily set for the needs of each individual car. The gas then continues on to the float which always keeps about one inch of liquid gas at the bottom of the vaporizer box. From here, the gas is pumped by the electric Flex fuel pump through the heat exchanger which is made up of 6 feet of coiled copper tubing which is spliced into your radiator hose. The gas now warm continues on to the heat sensor which controls the opening and closing of the automatic choke. The gas then continues on to the vaporizer box which measures about 10 inches square by about 3 inches wide where some of it vaporizes since it is warm. That which does not vaporize falls to the bottom of the box and is recirculated through the fuel pump, heat exchanger and heat sensor and back to the box again. Recirculation continues until it is vaporized. Air is drawn by your car through the Flex air filter, through the vaporizer box where it mixes with gasoline vapor and on into the air cleaner and from thence through your carburetor and on into your engine where it burns. Except at the time of starting and warming up when some liquid may be present, your car burns only vapor which is the only part of your gas that burns anyway. There will be no decrease in power with this explosive vapor in fact, you will probably notice an increase, perhaps dramatic, since your gas is almost 100% usable in vapor form. What happens if the carburetor backfires? There is a valve at the entrance of the vaporizer box that will allow no back-flow of fire into the box. If the pressure of the backfire is very much, a pressure sensitive spring on the by-pass door opens it up and the pressure escapes. Many of the Flex parts (air filter, fuel pump, pounds per square inch meter, etc., are replacable by going to your local auto parts store.

Though I have not yet seen Flex myself, I am convinced it works because Bill Green, regional director of a 9-state area, and especially his dad who sponsored me, are well-known reputable and long-time residents of Fort Morgan. Bill Green as I mentioned earlier, has a personal testimony to give concerning Flex of 110 miles per gallon.

5

FUEL MIZER
PO. BOX 6025
RICHARDSON,
TEX. 75080

VAPORIZER
WILL FIT ALL CARS

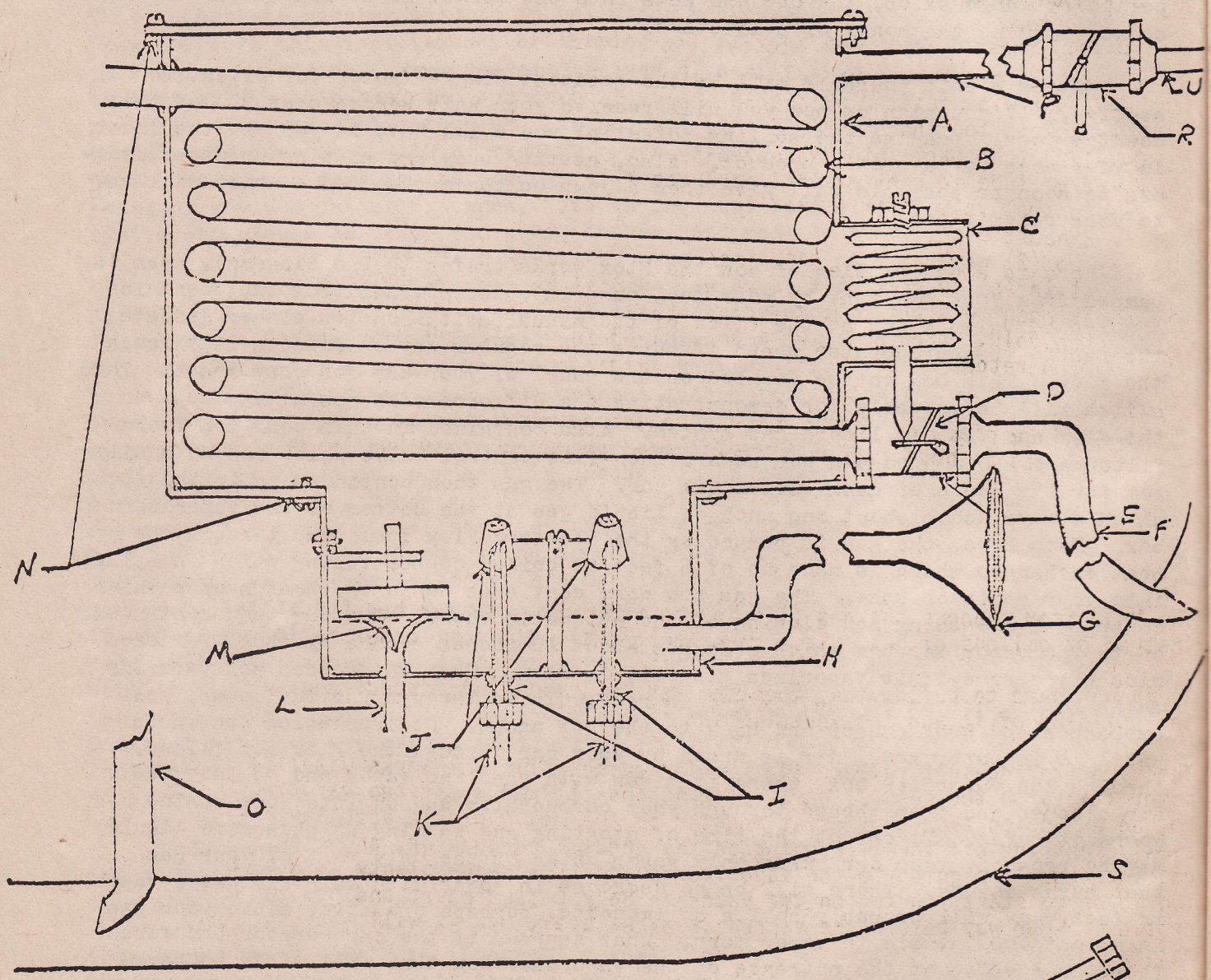

DETAILS

- A---7" diameter, 5" deep - 16 gauge-galvanized sheet metal.
- B---6 - 1/2" copper coils.
- C---Make large enough to accomodate thermostat from truck radiator shutter, obtainable from any wrecking yard.

Th
ir
It
th
Th
mo
up
si
ga
th
or
ma
P.

- D---Adjust butterfly valve where it is full open when cold.
- E---1" brass tube 2" long threaded on front end.
- F---1/2" copper tube into exhaust pipe - insulate.
- G---3" funnel down to 1/2" tube-mount behind fan, covered with fine screen.
- H---4" diameter pan, 2" deep--solder all fittings inside and out.
- I---1/4" copper tubing, swedge top end completely closed, then use #60 drill to make jets on each tube.
- J---Mount 2 large metal sewing thimbles (cut top off); solder 200 mesh screen on top.
- K---"T" these 1/4" tubes into gas line above fuel pump.
- L---Return overflow tube to main gas line below fuel pump.
- M---Float with tapered weight on bottom to seal tapered overflow tube.
- N---Gaskets top and bottom.
- O---1/2" tube back into exhaust pipe.
- P---1/2" tube to conventional carburetor.
- R---Control valve, (throttle).
- S---Exhaust pipe.
- T---Two (2) way valve in gas line above fuel pump - use same type thermostat as in (c) to control this valve. Adjust so line to conventional carburetor is open to start cold motor - install thermostat on side of exhaust manifold. When hot, turns on line to vaporizer and shuts off line to carburetor.
- U---Slip a piece of RUBBER hose over this tube to a copper fitting placed in hose that runs from top of valve cover to bottom of carburetor.

The Vaporizer changes the gas (liquid) to vapor so your car burns just like instead of gallons of gas. Some cars are getting 100 mpg, others a lot more.

It is not hard to build; the blueprint and full details if studied carefully will aid in the building of it and the installation.

The Vaporizer doesn't replace the regular carburetor, but works with it. When the motor starts on the regular carburetor and as the motor and the vaporizer warm up, an expansion type thermostat mounted on the hot manifold actuates a two way valve slowly shutting off the line going to the regular carburetor, and slowly turning it on as into the line going to the vaporizer which is already plenty warm by now causing the motor to start running on the vapors. So you just start and go, you may see a block or two on your way before the vaporizer takes over, but it will when warm enough, automatically.

S. - Only one question, the little tank that the copper coils are in that does the vaporizing is 7" diameter X 5" high. Some of the late model cars don't have that much extra space available under the hood. DOES YOURS??

MOST AUTO PARTS HOUSES HAVE THE LEVER TYPE TWO WAY VALVE, FOR USE ON PICK UP TRUCKS WHERE A SECOND GAS TANK IS ADDED.

8

Additional details on this fabulous device (Vaporizer) that I hope will help make it a little easier and understandable for you to build, and install on your car.

I would sincerely like to see millions of them built and put in service --- the way gas prices are today.

I have improved considerably on this design from what it was when it was first patented back in the early 1930's; my improvements make it more automatic and more self contained than the original.

One of the oil companies after testing several cars with the vaporizer on them was so impressed with the over 100 miles per gallon of gas, that they paid over two million dollars for the patent to keep it off the market from being manufactured. They shelved the patent, which has long since ran out.

I copyrighted my improved design so it can be built and installed by individuals like you, and a few million others.

There is nothing complicated about it. Have a sheet metal shop roll the 7" Dia. x 5" deep container and weld a seam on the side. This is the only welding I did on mine, all of the other joints I soldered inside and out.

The copper tube at the front entering the exhaust pipe also the one at back, I sealed with pumbers seal, that you can get at most hardware stores.

The throttle (R) should be mounted where the throttle arm will be connected to the rod that operates the throttle to the regular carburetor.

The thermostats (C) and at (T) must be covered (insulated). I had one of these vaporizers on a Lincoln and got well over 100 m.p.g.

If I can be of further help on this project, feel free to write.

One important thing, under Item "U" in the details, install a fine screen (150 mesh) over the fitting that goes into the lower side of the carburetor, this will prevent a fire if the motor ever backfired.

SUGGESTION, SEVERAL HAVE WRITTEN TO TELL ME THEY LEFT OFF ITEMS "C", "D" AND "E" AND THE VAPORIZOR WORKED OK WITHOUT THEM. THEY WERE IN THE DESIGN ONLY AS A SAFETY PRECAUTION WHICH EVIDENTLY ISN'T NECESSARY SAVES TIME IN BUILDING IT.

Last Januray (1981) we talked to a Mrs Albert Pogue in Winnepeg, Canada by telephone. She is the wife of Albert Pogue, Charles Pogue's brother and she confirmed that Charles Pogue was at that time still alive at the age of 81 and that he was living in a rest home there in Winnepeg. She would not tell us which one and she would not deny nor confirm any further questions. We got the impression that Albert was there with her as she kept asking someone else in the room what she should say to our questions, but she said he was not at home. She also said that Charles would not talk to anyone nor would he answer any of his mail and kept refusing to help in any way in our endeavor to make contact with him. Since they have been harrassed and called by phone more than they would like over the past 45 or so years, we will keep their phone number our secret and let them have some peace.

In our own research into a better way to use gasoline in automobiles we have yet to make our system work out as we had hoped. We can do a reasonable job of increasing efficiency at a constant highway speed and have better than doubled the gas mileage of our 1975 Oldsmobile with a 455cid V8 engine. However, we are unable to keep the system working at constantly varying throttle settings. It insists on flooding out at times of deceleration and leans too much upon acceleration, we have decided that if we are going to have this many problems we will attempt something in the range of super high mileage instead of just doubling mileage. Therefor we have dropped our research into the system shown on page 28 in favor of a super heating system that will totally and fully vaporize the fuel before it is ever mixed with the incoming air.

The latest world mileage record has been upped to more than 2000 mpg in Sydney Australia at the Warwick Farm motor racing track. A three-wheeler powered by a 10 cc (0.61 cubic inch) engine of the model airplane variaty drove the vehicle at an average of 16 miles per hour around the track and obtained a fantastic 2,236 mpg during a full throttle run. The second place vehicle used the sprint and coast method or full power for short bursts and then coasting with the engine off untill almost coming to a stop while the first place with the fantastic mileage used full throttle wide open for the entire run. The previous 1980 record was 1,368 mpg set in Great Britain beating out the then previous 1973 record of 379 mpg.

We purchased an original FISH Carburetor some time ago, made adapter and some linkage changes on our 75 Olds to install it. The carburetor made the car run excellent, increased power and acceleration but could not be adjusted lean enough to increase our fuel mileage. In fact it got worse (2.7 mpg) and after three weeks of adjusting and experimenting - we got tired of it and put the carburetor on the shelf. Mike Brown of The Madison Company - Box 206 - Berea, KY 40403 606-986-9744 has gone into production of the FISH Carburetor recently and guarantees that you can get a 20% increase or he will refund your money. We presume from his drawings that he has made a few modifications to the original FISH design and probably has more luck than we had with one of the original carburetors.

©

The
NEW



FIS carburetor

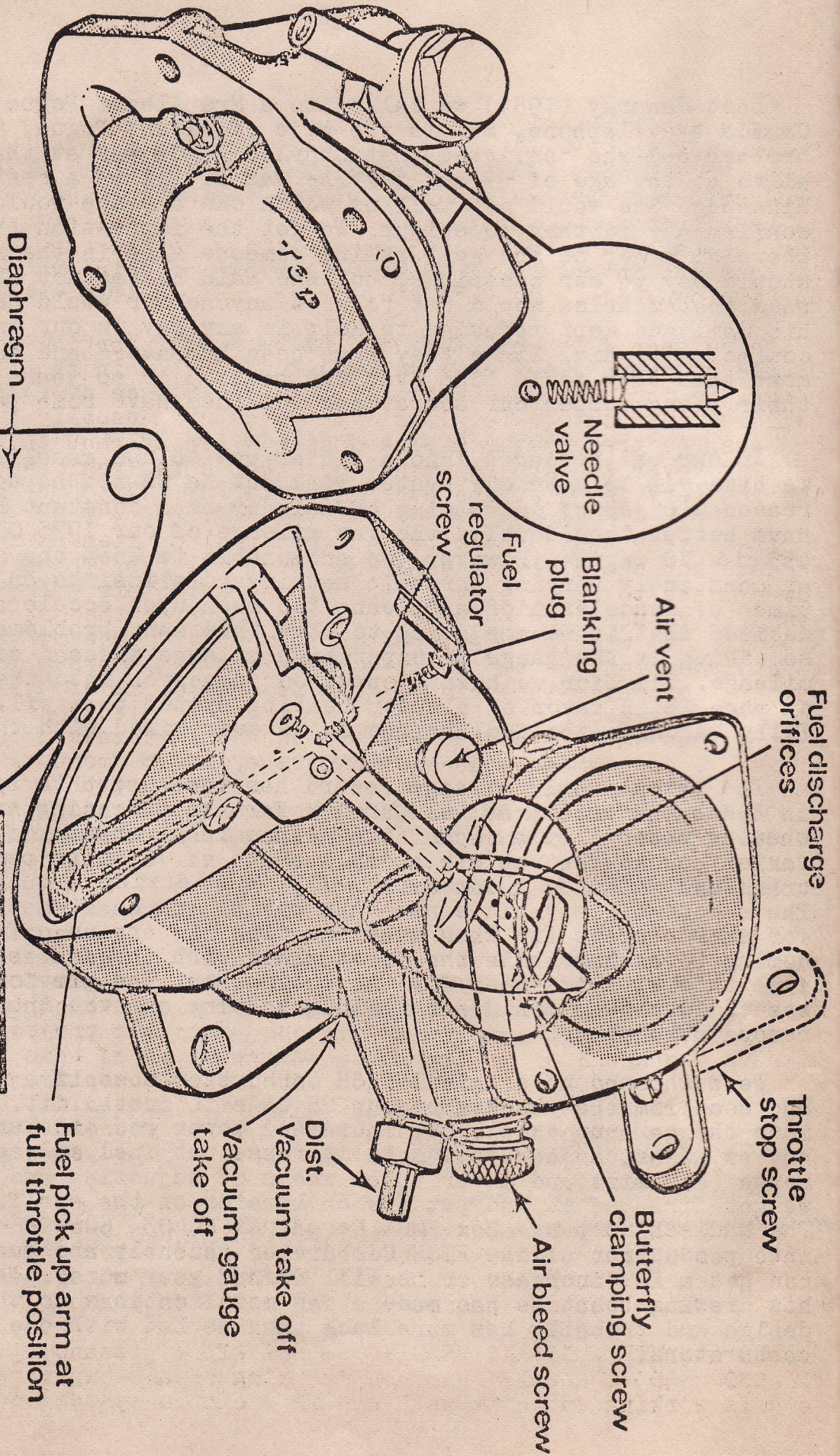
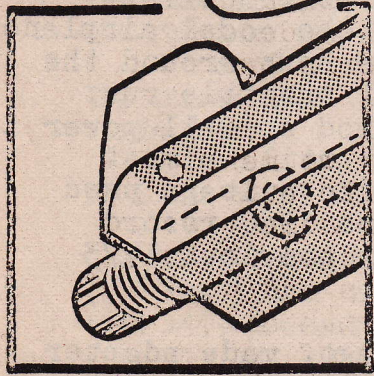

Fuel pick up arm at full throttle position

If your interested in one of these fish carburetors contact Mike Brown, not us. He sells them for \$189.50 with a money back guarantee of up to 20% increase in mileage or your money back. He has limited production so far and you may have to wait some time to get shipment of your order so be prepared to wait. He also sells Machinist Prints for the carburetor at \$24.95 and Castings to the carburetor at \$49.95 if your are interested in making your own or going into manufacturing on your own. Again contact Mike Brown, not us if you wish more info.

We've seen a lot of magazine and newspaper articles over the past couple of years about high mileage automobiles in the 100 mpg and up range. So far with our own investigations we see every one of these vehicles turn out to be ultra light machines, usually around 1000 lbs or less. We presume the public does not really want this type of car as they never seem to get many more than a few vehicles into production and very few of these ever get sold.

Every year there are literally hundreds of items going onto the market that claim to increase your fuel mileage. These range from the cow magnets to vaporizing screens to a little air valve that fits in your PVC vacuum line - be careful about buying these gadgets as very few (if any) will work any better than a good tune up. However a good water injection system can do wonders for most cars. If you invest in any type of water injection system be sure it is of the type that is controlled by above the throttle vacuum or by electronics, those that control the water flow by a vacuum line that connects below the butterfly valve can damage your engine as they inject more water during the deceleration than they do at any other time and this is the wrong time to inject the water. Be sure the system you purchase or build will give you more water during acceleration and less water during deceleration or you may end up with some broken exhaust valves or a broken head or piston.

Gail Dye of Rt #1 Box 9 - Benton, IL 62812 is the man we mentioned on page 27 as having been offered a \$100,000 a year job to quit playing around with his hobby. We haven't heard from him for some time so maybe he decided to take the job. Many people have contacted us in the last year to share a bit of info about their own projects and we would like to thank all these people and share a bit of this with all of you who read this book. Please do not abuse these people and if you wish a response from them when you contact them include a dollar to help them with postage and other expenses in answering your inquiries - or at the very least send them a self addressed stamped envelope no smaller than a #10 size ...

JOHN WESLING - Preston, MN 612-389-4440 has been working on an idea that uses a heat exchanger and modified carburetor parts and both heat and vacuum to double fuel mileage. He has his own shop and the number shown is his business phone, you can catch only during business hours.

JOE LASANTE (BOSSANO WELDING) - Box 223 - Bossano, Alberta CANADA TOJ OBO. 403-472-2475 has been working on his own version that he says is working out quit well and is a simple system to make. He says

that so far he can get at least 30 mpg on his 1978 Dodge D200 truck with 360 cid V8 engine and the engine runs very smooth with somewhat more power output.

RICHARD PAUL of Janesville, Wisconsin 608-756-5580 averages 80 mpg on his Oldsmobile Toronado. He says he got as high as 149 mpg with his first prototype model and is now working on another one to install in a Chevy with 283 V8 that he expects to do better than 180 mpg with.

HERB HANSON of Elgin, IL says he has developed a vaporizing system for use with alcohol. Using 140 proof alcohol in a Ford Pinto he says he gets 70 to 75 mpg and the engine produces more power, runs cooler & cleaner. The same car would only get 32 mpg on gasoline. Letters to the man have gone unanswered though and we do not have a current address.

JOHN G MESAL - Star Route 92334 - Box 374 - Wrightwood, CA 92397 has built a Pogue carburetor and has yet to be successful with higher mileage but says the engine runs very well, very smooth and has good power. Probably once he can get the thing adjusted correctly he will be able to get very good mileage.

JIM FOWLER (FOWLER MACHINE & MFG) - Box 1568 - Cortez, CO 81321 has been working on a few projects of his own. He has one prototype built now but does not yet have any test results. Says he will be willing to exchange info with any of you who are interested.

KEN MacNEILL (ADVANCE FUEL TECHNOLOGY) - Box 9478 - Winter Haven, FL 33880 phone 813-956-4040 Says he can effectively double the gas mileage of most any car. He is an information collector like many of us and will talk your ear off if you let him.

RICHARD GORANFLO (MILEAGE UNLIMITED) - 109 Longleaf Lane - Altamont Springs, FL 32701 305-869-4939 Has been giving Seminars and claims to get 45 to 65 mpg on a 1976 Cadillac with 425 cid V8 engine.

BERNARD WHERRY - Box 148 - Saint Mary's, WV 26170 304-684-7223 Has been working on these things for several years. He now has three different carburetors and one of them gets him 60 mpg on his Chrysler Cordoba. Last we heard about him was that he was going into production and market one of the carbs at about \$250.

RAY COVEY - 9700 Trinidad - El Paso, TX 79925 Has worked on his device for more than a year now and has applied for patent. He has been able to get as high as 110 mpg under some testing but normally the average is not quite that good. He has had a couple of mechanics helping him and has worked out just about every problem anyone could think of ever having in a system of this type. Ray has been in touch with us quite often during his research and he now feels that the device is about ready to market. He is looking for backers if you might be interested get in touch with him.

JOHN DRAPER of Crofton, MD 301-261-6847 Says he has fed all info in regards to the characteristics of gasoline into a computer and then fed in all the info he could get on the Pogue carburetor into the same computer, and the computer says the system will work.

ARTHUR SGRIGNOLI the man mentioned on page 27 with the photographs of him and his brother along with the Pogue carburetor he built has't had much time to further his research. But for those of you who might be more interested in his device his own drawing has been reproduced here on this page. As you can see there are some dimensions given.

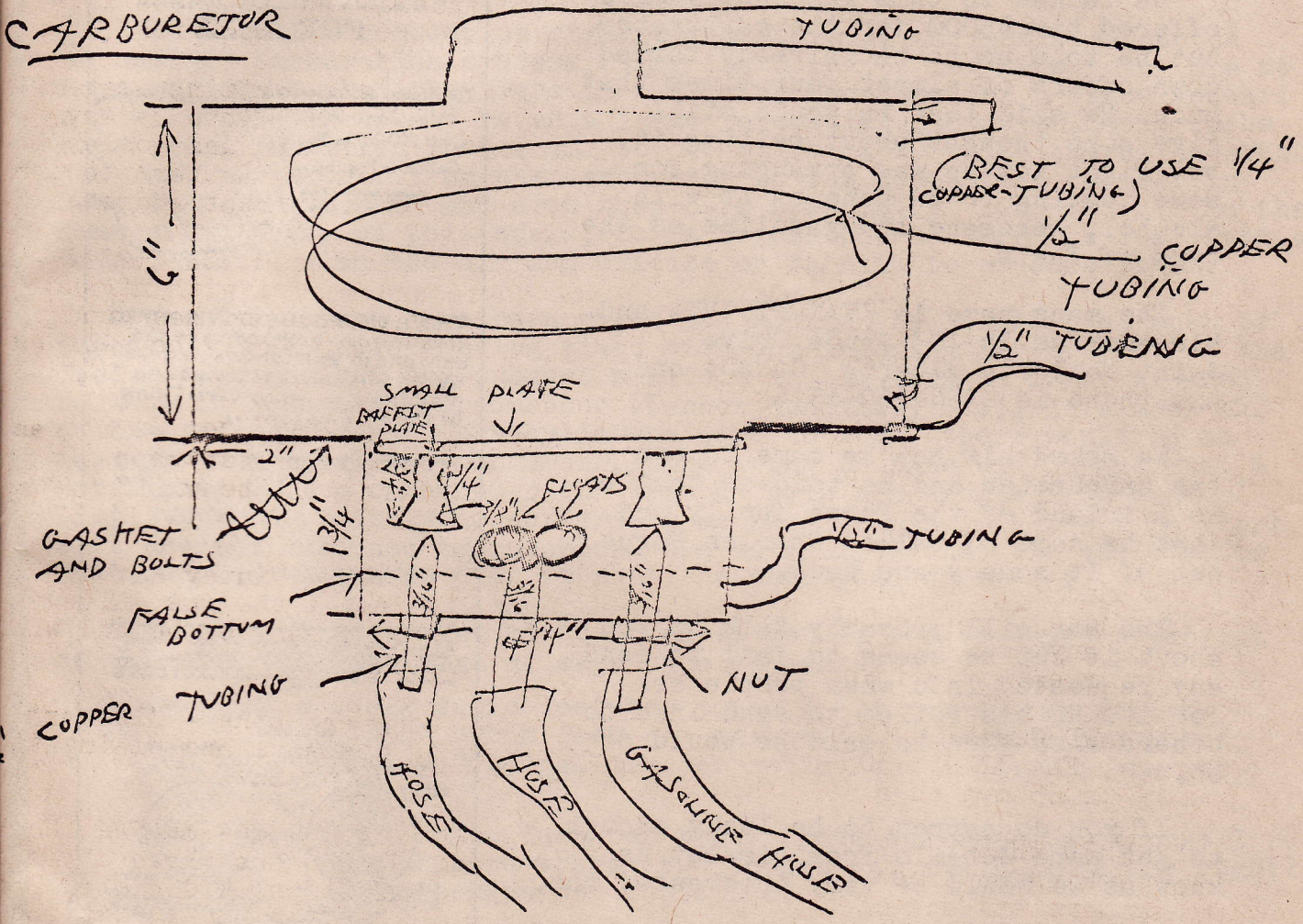

WILLIAMS ROTORCRAFT - Rt # 6 Box 118 - Oseto, MO 63020 Supposedly has a fuel vaporizer that they are making but we have no details on it nor do we know if they are still building the device.

FRED HOLSTE - 3920 Federal Hill Rd - Jarrettsville, MD 21084 Also has been working on one of these vaporizer carburetors. So far he has obtained up to 45 mpg. He may not give you any answers though if you contact him as he told us that he would deny having obtained this type of mileage if we printed his name.

For those who don't believe the Pogue is real, we have reproduced on the next page - a copy of an advertisement where one was at one time on the market for sale. This man still has the carburetor (he never sold it) and last we heard was going to do some testing on it. We tried to get a few photographs and some further details and dimensions from him and he said he would send them but has not done so.

Sorry about the poor reproduction but the best copy we have is a poor reproduction itself and copy machines just can't make it any better.

We talked to this man last year & offered him \$5000 for the carburetor but he told us he had already turned down offers of almost four times that much. He said that he would still give some thought about selling it, but right now he was arranging for some testing to be done on it with alcohol, kerosene and gasoline as the type of fuels.

The mans name is IVAN PINIVTA and his address is 103 Houde Drive Saint Norbert, Alberta CANADA and his phone is 204-269-1514

We asked him how he came to own the carburetor and he told us that he is a friend of the Pogue family and that he sort of talked Charles Pogue out of it some years back.

The man will probably talk to you about it but he seems to fail to send any requested info when people ask for it. He has failed to send info to others also when he said he would do so.

If you do happen to be lucky enough to get more details from him let us know as we would be very interested too.

This ad by the way, appeared in the July 1980 issue of Hemmings Motor News.

**INCREDIBLE FIND
WORLD FAMOUS**

**POGUE
CARBURETOR
FOR SALE**

Prominent Automotive
Men Convinced
Over 200 Miles Per
Gallon is Possible--

Canadian Automotive Trade

1974

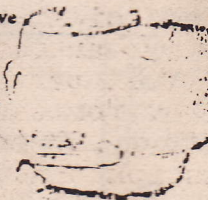

This is the POGUE or WINNIPEG carburetor... believed to be the only one in existence. Could be worth MILLIONS if tested and modified... today's cars. Think of the possibilities.....

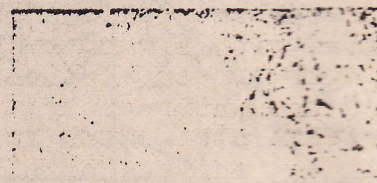

This diagram illustrates the general construction of the carburetor inspected by Mr. Royal of Winnipeg, Man. which among other things are claimed. This does not represent Mr. Pogue's carburetor as it is complete in all particulars, as the carburetor which is being offered is complete and accurate in every way possible and true.

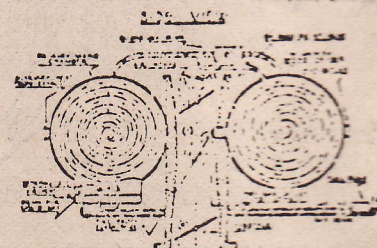

This diagram illustrates the general construction of the carburetor inspected by Mr. Royal of Winnipeg, Man. which among other things are claimed. This does not represent Mr. Pogue's carburetor as it is complete in all particulars, as the carburetor which is being offered is complete and accurate in every way possible and true.

**TO BE SOLD BY
HIGHEST BID
RECEIVED BY
JULY 31, 1980**
successful bidder
notified by phone

owner has the
right to refuse
unsatisfactory bid.

Interesting trades
considered.

POGUE CARE. P#204 269-1514
ST. NORBERT, MAN., CANADA

Oil companies, oil sheiks need not apply

For those of you who desire full and complete patent drawings for any of these carburetors, order them from the U.S. PATENT OFFICE - WASHINGTON, DC 20231 not from us. They cost 50¢ each and you must let them know the patent number, the inventors name and the issue date. They are slow like all other government agency's so be prepared to be about 90 days in getting your order from them.

BRAD DENNIS a combustion engineer in St Paul, MN has been quoted as saying: Carburetion systems being installed on new cars today are no more efficient than they were in 1920. The best use for a fixed venturi style carburetor should be as a large paperweight. Todays liquid carbs expel fuel particles in the 400 to 500 micron size which travel at about 150 feet per second from the carburetor to the combustion chamber in less than .07 seconds and even then only spend about .025 seconds in the combustion phase. On this basis, it is impossible to turn the fuel into a vapor, mix it with the air and oxidize or burn it to produce power.

Pogue and others have been right all along, the liquid fuel must be vaporized fully before being mixed with the incoming air or most of the fuel goes right out the exhaust manifold in the form of HC or as most us know it Unburned Hydrocarbons (Carbon Monoxide, Etc). If almost all of the fuel going into the cylinders were to burn, there would be no need for the catalytic converter. Cars using propane and butane fuel & not fitted with a carburetor for liquid fuels are exempt from federal laws requiring catalytic converters as the fuel is in a vapor to start with and the unburned hydrocarbons are so minimul that the vehicles do meet federal standards even without the catalytic converter.

Some other trivia that might interest you if you do start a project of your own with any high mileage type of system:

Gasoline = .0222 cubic feet per pound / 6.1 pounds per gallon
.13542 cubic feet per gallon / 45.6 pounds per cubic foot / 7.48 gallons per cubic foot / 124,000 btu per gallon

Air = 13.1 cubic feet per pound (note our formula on page 3 has this reversed even though the end figures are right)
.0764 pounds per cubic foot

It seems that carburetion is still today what might be considered a black art - very few people can seem to agree on the correct Air/Fuel mixture for the modern or any other internal combustion engine. The old standard of 15 to 1 is just a bunch of hogwash and anyone can prove it. However it seems that no-one can prove what is the correct mixture. Our car runs on a 49:1 ratio average - Ford has experimented with some that ran 20:1 - some deisels can easily run 40:1 and yet deisel does not have 2.6 time the btu as gasoline... ?????? So who is right? Probably anyone and everyone. If you can make your car run on a 15:1 ratio with whatever fuel preparation system it has then that is correct for that system. If you can make it run on a 100:1 ratio then that would be the correct ratio for that system. Neither system would make the engine run using the ratio of the other

GOOD LUCK

A Wallace

WASHINGTON--The nations car owners are being "taken for a ride". according To Allen Wallace, author and high-mileage expert. Though the exterior of the new cars of the 80's are becoming more futuristic, basic carburetor design...the technical key to greater fuel efficiency...hasn't changed appreciably in more than half a century. In a society where anything more than 24 months old is usually obsolete, it is shocking that drivers are willing to put up with this kind of engineering fiasco.

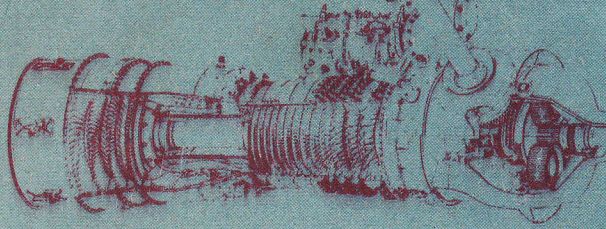

This jet engine runs on simple kerosine, a crude and relatively inexpensive fuel. It is a new design employing important refinements. And, it totally replaces its predecessor which was in production for just 38 months. Why? Because, through re-engineering, it was possible to double the range of aircraft equipped with this new engine...with only half the fuel consumption--a four-fold increase in overall efficiency. If this kind of improvement seems unrealistic for automobiles, consider the winner of the Shell Mileage Marathon: a special, three-wheeled vehicle that delivered an incredible 1,368 miles per gallon. There's room for improvement.

The device at the forefront of the current race for record-breaking mileage is the legendary Pogue Carburetor. Its claim to fame is its mileage test conducted by the Ford Motor Company of Canada in which it achieved a remarkable 25.7 miles per pint--or 205 miles per gallon on a regular Ford sedan! That's a hot enough news item to bounce off Telstar today. If all this sounds very "21st Century", consider that Charles N. Pogue, its inventor, was born at the turn of the century...now 81 years old, and his original patents expired in 1953!

As a result, anyone can build this revolutionary device (many people have already done so) and begin multiplying fuel efficiency. Spiraling fuel costs in the last 2 to 5 years has started a wave of popularity for the Pogue creation, spawning seminars and rallies across the nation. Hundreds of individual carburetors have been built by arm-chair mechanics using, in part, the information and technical drawings provided in this manual. And, a few versions are even being offered to the public...under heavy opposition from Detroit, the oil companies, and the environmentalist agencies.

The eye-opening information in this book will allow you realize what the potentials are...and, offers several methods of achieving them with your own car. But, it is the hope of the editors that the impact of this book will have an effect that reaches even further...to the inner workings of automobile design. The time has come to produce fuel-efficient carburetors as a standard feature on all new cars. The time has come to declare our independence from OPEC and all foreign oil imports. And, the time has come to break the strangle-hold of oil companies on the jugular vein of domestic transportation and energy costs.

What is it going to take to get some results? Perhaps, when enough people realize how existing potentials are being thwarted and are willing to join together with the cry, "give us higher gas mileage or give us death!", something revolutionary will occur.